

# 聲學大師徐亞英 逝世一週年紀念音樂會

*The Memorial Concert for the Master of  
Architectural Acoustics-Albert XU*









# 總監的話

## Words from the General and Artistic Director

今日我們懷著無比的思念齊聚一堂，追憶國際聲學大師徐亞英老師，雖然徐老師已逝世一週年，但他的聲學靈魂仍然在這片空間迴盪，時刻提醒並激勵著我們，不斷去探索聲音的奧妙。

「沒有音樂，建築成為一個瘖啞的空殼子。」此話體現了徐亞英老師對音樂與建築之間共鳴的深切理解。正是這份理念，賦予了衛武營獨特的音場，使這座融匯自然與藝術的場館成為現今的模樣。

衛武營與徐亞英老師的家人共同策劃這場音樂會，除了分享徐老師畢生摯愛的樂章，徐老師的女兒徐卉，特別為了紀念父親創作了一首感人至深的作品，它如情感的波濤，流淌於我們心間，帶來深刻的懷念與無盡的愛意。

徐亞英老師的孫女徐麥粒，也以她獨到的視角透過影像為我們展現另一層次的感受，為這場演出增添一份珍貴的獻禮。我們也透過紀錄片導演楊守義動人的影像作品，回顧徐老師的生命之路，讓我們更深刻地體會這位偉大聲學家的內心世界。

這場紀念音樂會，不僅是對徐亞英老師的追思，在徐亞英老師精心設計的音樂廳中，每一段旋律和殘響都傳承著他的理想與故事。讓我們帶著對徐老師的敬愛與深切懷念，共同走過一段穿越時空、充滿共鳴的音樂旅程。

We are together today to remember the internationally renowned acoustician Albert XU. Though he has been gone for a year, his spirit lives on in the acoustics of this space as a constant reminder and inspiration for us to keep exploring the mysteries of sound.

He once said, "Without music, a building is merely a deaf, mute, empty shell," a clear comment on his profound understanding of the relationship between music and architecture. It is precisely this concept that has given Weiwuying its unique sound field and made it a contemporary model of how to fuse nature and art.

For this concert jointly planned by Weiwuying and Albert XU's family, we will share pieces of music he adored. His daughter, Mimi XU, has written a deeply moving piece dedicated to him, full of longing and unmeasurable love that will penetrate and flow through our hearts.

With her unique perspective, Maïly BEYRENS-XU will provide us with a precious visual commemoration of her grandfather. In addition, director YANG Shou-yi has prepared a touching documentary for us to look back on this acoustic master's life and gain a deeper understanding of him.

The concert is by no means only a tribute to XU. In this hall, which he painstakingly designed, every melody and every reverberation conveys his ideals and story. So let us embark on a musical, resonant journey back through time to remember our beloved and greatly missed Albert XU.

衛武營國家藝術文化中心  
藝術總監  
General and Artistic  
Director of Weiwuying

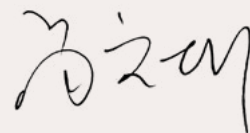

# 徐亞英夫人的一段話

## Words from Albert XU's Wife

我是徐安娜，徐亞英離開已一年了，天人相隔，斷腸人在天涯。我夢到了，他到了天堂仍在繼續為天使們創作，音樂廳、展覽中心、歌劇院、還是那麼忙碌工作。他要我等他一下，我醒了。夕陽西下，斷腸人在天涯。

I am Anna XU, and a year has passed since Albert XU departed this world. Separated by the heavens, my heart aches, adrift in solitude. Last night, I dreamed of him in paradise, tirelessly creating for the angels-concert halls, exhibition spaces, grand opera houses. His hands still busy, his vision undimmed. He turned to me and said softly, "Wait for me, just a moment more." Then, I awoke. Now, as the sun sinks low, casting its golden farewell, the heartbroken wanderer lingers in the distance, longing for the day our paths will meet again.

徐亞英夫人  
Albert XU's Wife

徐安娜





# 演出節目

## Program

【影片】楊守義《聲學交響曲：徐亞英的探索之旅》

穆索斯基／拉威爾改編：〈漫步〉，選自《展覽會之畫》

貝多芬：第二樂章〈慢板〉，選自第四號交響曲，作品 60

布拉姆斯：第一樂章〈不太快的快板〉，選自第二號交響曲，作品 73

穆索斯基／拉威爾改編：〈漫步〉，選自《展覽會之畫》

貝多芬：第二樂章〈稍快板〉，選自第七號交響曲，作品 92

德布西：第一樂章，〈海上的黎明到中午〉，選自《海》

---

中場休息

---

【影片】徐麥粒 (YLİAM) 《回聲的源頭》

徐卉《三水》（世界首演）

I. 水的力量

II. 水的流動

III. 水的深沉

【 Video 】 YANG Shou-yi *Acoustic Symphony: The Journey of Albert XU*

M. MUSSORGSKY/ Arr. by M. RAVEL: "Promenade" from *Pictures at an Exhibition*

L. van BEETHOVEN: Mov. II. Adagio, from Symphony No. 4, Op. 60

J. BRAHMS: Mov. I. Allegro non troppo, from Symphony No. 2, Op. 73

M. MUSSORGSKY/ Arr. by M. RAVEL: "Promenade" from *Pictures at an Exhibition*

L. van BEETHOVEN: Mov. II. Allegretto, from Symphony No. 7, Op. 92

C. DEBUSSY: Mov. I, "From Dawn till Noon on the Sea" from *La Mer*

---

Intermission

---

【 Video 】 Maily BEYRENS-XU (YLĪAM) *Where the Echo Comes from*

Mimi XU: *Sānshuǐ* (*Three Waters*, World Premiere)

- I. Strength
- II. Fluidity
- III. Depth





# 徐亞英

Albert XU

徐亞英，國際知名旅法建築聲學家。原籍蘇州，1934年生於天津，畢業並任教於清華大學建築系，師事梁思成，並獲聲學家馬大猷教授及美國著名聲學家利歐·柏仁內克博士指導。

從1957年起即專注於建築聲學，並投入中國國家重大計畫「國家大劇院」的聲學設計和研究，在1958年就進行了1比10的大劇院聲學縮尺模型測試，並著手研究「早期反射音」對歌劇院音質的重要性，及如何改善池座中部貴賓席的聲學缺陷，之後獲邀赴法國音樂聲學研究中心從事音樂廳聲學研究。

於1987年在法國巴黎成立徐氏聲學事務所，作為建築聲學顧問，提供國際高規格表演場館精密聲學設計的解決方案，與國際知名建築大師貝聿銘、法蘭克·蓋瑞、波宗巴克、里卡多·波菲、保羅·安德魯等人是長期搭檔，也一直與音樂家及指揮家充分的交流和合作。並在1995年和2004年分別得到法國建築科學院授予的建築聲學最高獎項「最佳技術顧問獎」及「建築技術科研成就獎」。

Albert XU is an internationally renowned architectural acoustician based in France. XU was born in Tianjin in 1934 with ancestral roots in Suzhou and taught at the Department of Architecture of Tsinghua University, where he studied under LIANG Si-chung. He also received guidance from acousticians MA Da-you and Dr. Leo BERANEK, a celebrated American scholar.

Devoted to the study of architectural acoustics since 1957, XU carried out the acoustics design and research for the establishment of the National Centre for the Performing Arts, China. He conducted the test for the 1:10 scale acoustic model of the opera house as early as in 1958, undertook the research on the importance of early reflections to the sound quality of opera houses, and sought solutions on how to mitigate the acoustic deficiency of the VIP seating in the middle of the auditorium. He was later invited by the French Institute for Research and Coordination in Acoustics/Music (IRCAM) to conduct research on concert hall acoustics.

He founded XU-Acoustique in Paris in 1987 and served as a consultant on architectural acoustics,

providing solutions to the acoustic design of high-level international venues. He has established long-term partnerships with various internationally renowned architects, including I. M. PEI, Frank O. GEHRY, Christian de PORTZAMPARC, Ricardo BOFILL, and Paul ANDREU; he also maintains close relationships with many musicians and conductors. He was awarded the Best Technical Consultant Award in 1995 and the Grand Silver Medal for Research and Technique in 2004 from the Académie d'architecture.





# 徐亞英聲學設計精選作品

## Selected works of Albert XU's Acoustic Design

### 音樂廳、歌劇院

- 2020 | 蘇州灣大劇院，中國
- 2019 | 上海音樂學院歌劇院，中國
- 2019 | 卡薩布蘭卡大劇院，摩洛哥
- 2018 | 衛武營國家藝術文化中心，臺灣
- 2013 | 里約熱內盧藝術城，巴西
- 2010 | 歐納西斯文化中心，希臘
- 2009 | 哈薩克中央音樂廳，哈薩克
- 2007 | 米格爾·德利貝斯文化中心，西班牙
- 2007 | 聖彼得堡愛樂大廳，俄羅斯
- 2005 | 上海東方藝術中心，中國
- 2005 | 盧森堡愛樂音樂廳，盧森堡
- 2004 | 寧波大劇院，中國
- 1999 | 澳門文化中心，澳門特別行政區
- 1997 | 巴黎音樂城，法國
- 1994 | 普萊耶音樂廳，法國
- 1993 | 日內瓦湖邊穀倉音樂廳，瑞士
- 1992 | 波爾多大劇院，法國
- 1990 | 蒙彼利埃文化中心，法國
- 1989 | 梅茲音樂廳，法國

### 劇院

- 2013 | 巴林國家劇院，巴林
- 2012 | 弗里堡中心劇院，瑞士

- 2005 | 阿什哈巴德國家劇院，土庫曼
- 2005 | 法國國立鳳凰劇院，法國
- 1998 | 加泰隆尼亞國家劇院，西班牙
- 1987 | 布列塔尼國家劇院，法國

### 文化中心、藝術學院

- 2008 | 莫里斯·拉威爾音樂學院，法國
- 2006 | 雷恩多元文化中心，法國
- 2003 | 韋利濟—維拉庫布萊藝文中心，法國
- 1998 | 阿爾澤特河畔埃施文化中心，盧森堡
- 1997 | 巴黎日本文化館，法國
- 1994 | 巴黎美國文化中心，法國

### 會議中心

- 2013 | 羅馬會議中心，義大利
- 1999 | 阿什哈巴德會議中心，土庫曼
- 1994 | 馬德里會議中心，西班牙
- 1994 | 蘭斯會議中心，法國
- 1992 | 南特會議中心，法國

### 多功能場館

- 2023 | 臺北大巨蛋，臺灣
- 2020 | 高雄流行音樂中心，臺灣
- 2012 | 聖淘沙名勝世界劇院，新加坡
- 2008 | 亞洲國際博覽館，香港特別行政區
- 2005 | 臺北小巨蛋，臺灣
- 2003 | 布達佩斯體育場，匈牙利
- 1989 | 瘋馬夜總會，法國

### 博物館、法院、機場、其他

- 2015 | 盧森堡大學「知識之家」，盧森堡
- 2012 | 美秀美術館，日本
- 2008 | 多哈伊斯蘭藝術博物館，卡達



- 2007 | 拉羅克當泰龍國際鋼琴音樂節，法國
- 2007 | 蘇州博物館，中國
- 2006 | 盧森堡現代美術館，盧森堡
- 1999 | 貝魯特國家博物館，黎巴嫩
- 1997 | 法國國家管絃樂團排練室，法國
- 1991 | 巴塞隆納機場，西班牙
- 1989 | 里昂法院大樓，法國
- 1989 | 羅浮宮金字塔廳與馬利中庭，法國
- 1963 | 東海大學路思義教堂，臺灣

### CONCERT HALLS & OPERA HOUSES

#### CONCERT HALLS & OPERA HOUSES

- 2020 | Suzhou Bay Grand Theater, China
- 2019 | Shanghai Opera House, China
- 2019 | CasARTs (Grand Theatre of Casablanca), Morocco
- 2018 | National Kaohsiung Center for the Arts (Weiwuying), Taiwan
- 2013 | Cidade das Artes, Brazil
- 2010 | Onassis Foundation, Greece
- 2009 | Kazakhstan Central Concert Hall, Kazakhstan
- 2007 | Miguel Delibes Cultural Center, Spain
- 2007 | St. Petersburg Philharmonic, Russia
- 2005 | Oriental Art Center, China
- 2005 | Luxembourg Philharmonic Hall
- 2004 | Ningbo Opera House, China
- 1999 | Macau Cultural Center, Macau
- 1997 | Cité de la Musique, France
- 1994 | Salle Pleyel, France
- 1993 | La Grange au Lac, Switzerland
- 1992 | Bordeaux Grand Theater, France
- 1990 | Le Corum, France
- 1989 | Arsenal, France

## THEATERS

- 2013 | Bahrain National Theater, Bahrain
- 2012 | Equilibre Theater, Switzerland
- 2005 | Ashgabat National Theater, Turkmenistan
- 2005 | Valenciennes National Phoenix Theater, France
- 1998 | TNC National Theater of Catalonia, Spain
- 1987 | National Theater of Brittany, France

## CULTURAL CENTERS & CONSERVATORIES

- 2008 | Maurice Ravel Conservatory, France
- 2006 | The Champs Libres Center, France
- 2003 | L'Onde Théâtre - Centre d'art, France
- 1998 | Kulturfabrik, Luxembourg
- 1997 | Japanese Culture House of Paris, France
- 1994 | American Center, France

## CONGRESS CENTERS

- 2013 | New Rome Convention Center, Italy
- 1999 | Ashgabat Congress Center, Turkmenistan
- 1994 | Madrid Congress Center, Spain
- 1994 | Reims Congress Center, France
- 1992 | Nantes Congress Center, France

## AMPLIFIED VENUES

- 2023 | Taipei Dome, Taiwan
- 2020 | Kaohsiung Music Center, Taiwan
- 2012 | The Festive Grand Theater, Singapore
- 2008 | Hong Kong Arena, Hong Kong
- 2005 | Taipei Arena, Taiwan
- 2003 | Papp László Budapest Sportaréna, Hungary
- 1989 | Crazy Horse, France

## MUSEUMS, COURTHOUSES, AIRPORTS & OTHERS

- 2015 | Maison du Savoir, Luxembourg
- 2012 | Miho Chapel, Japan
- 2008 | The Museum of Islamic Art, Qatar
- 2007 | Festival International de Piano, France
- 2007 | Suzhou Museum, China
- 2006 | MUDAM (The Contemporary Art Museum of Luxembourg), Luxembourg
- 1999 | The National Museum of Beirut, Lebanon
- 1997 | ONDIF Rehearsal Room, France
- 1991 | Barcelona Airport, Spain
- 1989 | Courthouse in Lyon, France
- 1989 | Louvre Pyramid Hall and the Court Marly, France
- 1963 | Luce Memorial Chapel, Taiwan

# 羅浮宮金字塔廳與馬利中庭

Louvre Pyramid Hall and the Court Marly

所在地 Location | 法國 · 巴黎 Paris, France

建築設計 Architect | 貝聿銘 I. M. PEI

完工 Complete | 1989



# 日內瓦湖邊穀倉音樂廳

La Grange au Lac

所在地 Location | 法國 · 艾維揚 Evian, France

建築設計 Architect | 派翠克 · 布尚 Patrick BOUCHAIN

完工 Complete | 1993



# 巴黎音樂城

Cité de la Musique

所在地 Location | 法國 · 巴黎 Paris, France

建築設計 Architect | 克里斯蒂安·德·波宗巴克 Christian de PORZAMPARC

完工 Complete | 1997



# 盧森堡愛樂音樂廳

Luxembourg Philharmonic Hall

所在地 Location | 盧森堡·基希貝格 Kirchberg, Luxembourg

建築設計 Architect | 克里斯蒂安·德·波宗巴克 Christian de PORZAMPARC

完工 Complete | 2005



# 衛武營國家藝術文化中心

National Kaohsiung Center for the Arts (Weiwuying)

所在地 Location | 臺灣 · 高雄 Kaohsiung, Taiwan

建築設計 Architect | 麥肯諾建築師事務所 Mecanoo

完工 Complete | 2018

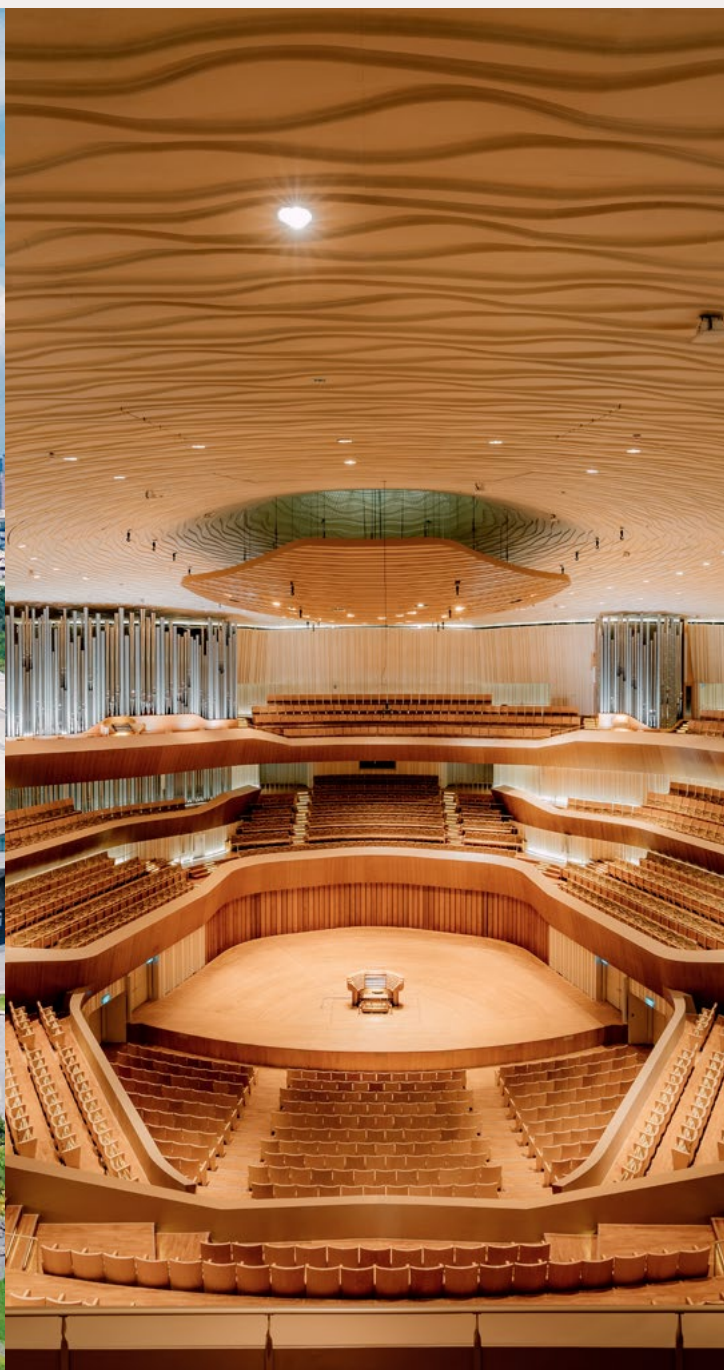





“ 減少，才能給予更多。  
Do less to give more ”

“ 要如水一般，堅韌、靈活，又有深度……  
Be like water, strong, adaptable yet with depth... ”

“ Pourquoi pas? (法文：為什麼不呢?)  
"Pourquoi pas?" ("Why not?" in French especially) ”

“ 所看即所聽。  
Seeing is hearing ”



# 緬懷尊師

## In Memory of My Esteemed Mentor

撰文 | 鄭傑元

Written by CHENG Chieh-yuan

華人建築聲學家徐亞英老師生前曾說，高雄衛武營國家藝術文化中心，是他生命後期最滿意的作品，2018年啟用，直至2023年10月21日以果陀劇場的舞台劇《冒牌天使》進行歌劇院聲學測試，終將五年牽掛於心的衛武營全部廳院滿場聲學測試完成，彷彿是以此作為生命的圓滿總結，鞠躬盡瘁，成就了臺灣的表演藝術，就此與人間告別。

建築聲學，是物理、音樂、建築及科學的總合，在建築空間捕捉來自演奏家們所產生稍縱即逝的聲波，賦予音樂流淌在一個經過設計的建築場域，使得美好的樂音能感動人心，是徐老師投入建築的真正目的。

徐老師參與過的建築聲學作品，遍佈世界不同國家和地區，設計和建造了近百座文化演出和藝術展覽性建築，有的在繁華的歐美、亞洲都會區，也有如偏遠的鄉鎮、草原及北非。經手的建築從地方的表演藝術文化中心、音樂廳、老舊大小空間、劇院、國際當代展演中心，到圖書館、博物館、會議廳、體育場館及市政法院等，與六位「普立茲克建築獎」得主的建築大師合作，成績斐然，包括美籍華裔建築大師貝聿銘、美國建築師法蘭克·蓋瑞與法國建築師波宗巴克等。（這在節目冊其他篇章會做介紹，所以這裡僅放幾位重要合作的建築師名字）

全球極為少數的聲學家，以建築材料為手段，成為駕馭無色無形聲波的舵手，其中簡易如降低餐廳噪音，難如打造一個優質傳導樂音的音樂廳空間，讓演出者得以充分自我表達，並將發聲的每個瞬間分享給觀眾。老師傾注畢生熱情於建築聲學，一生的願景是將對音樂的想像實現於建築空間中，在有條件的體積、形狀和材料制約中，駕馭著無形、無色、即生即滅的聲波，準確傳導聲波，同步處理空間中的留白寂靜，將灰階地帶留給空間殘響，塑造出一個有功能性的音場，成就一個個足以激盪靈魂的聲學場所。

徐老師不同於其他建築聲學家，每個設計案必定親力親為地投入，從事超過一甲子且設計案遍佈

全球，他必定先鉅細靡遺地研究每個在地文化的屬性、在地產業材料及其特殊需求，以此為本，進而開展設計，內容不僅只以西洋古典音樂聲響為主，也兼顧了各地方文化的音樂、樂器及表演藝術的特性，在中亞、東亞，深入東方樂器及戲曲在音樂廳環境的探討；在卡達，研究阿拉伯音樂種類、語言、宗教特性等。此外也常考慮與研究如何利用在地特色活化在地產業，例如在臺灣清華大學君山音樂廳的設計前期，徐老師就到處拜訪新竹當地的玻璃回收工廠，研究利用廢棄玻璃製作成聲學擴散材的可能，推動在地特色與學校藝術系的鏈結，以期設計出達到聲學原理的音樂廳材料。巴西里約熱內盧藝術城排練廳中，就有著由老師獨創設計，無償由巴西本地生產的三角開孔吸音磚。

徐老師從前期的規劃，到每階段的推進，不停歇的行旅腳步，跑遍大半個地球，不辭辛勞地出現在各地的大小會議室、工地、鷹架、貓道等，上下攀爬視察施工中的音樂廳。每每他到了臺灣及其他各地，不僅看不到長途飛行的疲累，反而精神奕奕地如沒有時差的干擾，以極強戰鬥意志帶領著臺灣團隊，開始滿檔的工作行程。



徐老師於 20 年前在巴黎結識了來自臺灣的林貴榮建築師及已逝的許博允先生，自此開啟了與臺灣深厚的因緣。後在文建會主委的委請下，為臺灣各地方文化中心做聲學診斷評估，之後為了臺北小巨蛋、大巨蛋、臺北市立交響樂團歌劇《阿伊達》、衛武營國家藝術文化中心、高雄流行音樂中心，東海大學路思義教堂、臺北市音樂與圖書中心、遠東國際會議中心葡萄園音樂廳、新竹清華大學君山音樂廳等大小案子，不遠千里地從巴黎或其他國家，一次次的飛來臺灣，遺愛在臺灣。

徐老師一生持以文人的自重處世，對人性、建築、美學及音樂等總堅守基本價值。每座經手過的建築，在與建築師之間合作的歷程、設計的源由、思維的深度，徐老師總從建築的角度行藝術關懷之實，以建築空間來傳遞聲音的極致美學，而最後完工的豐碩成果，總是歸功給建築團隊。老師既嚴肅地遵循原則，在聲學品質的要求一絲不苟，卻也放下不合用的理論，每每遇到設計溝通阻礙時，總是先理解對方的困難，嘗試開發出新的聲學設計工法，也在冗長施工過程中，發揮整合團隊與業主溝通的柔軟，一直推動團隊朝著聲音高品質邁進。對於聲學家應有的氣度與價值觀，更是不遺餘力地大聲疾呼，認為聲學家應比建築師敏銳在藝術文化的本質，讓建築承載出另一層責任，建築與音樂的藝術之思，決定人生定義，讓建築為藝術服務。

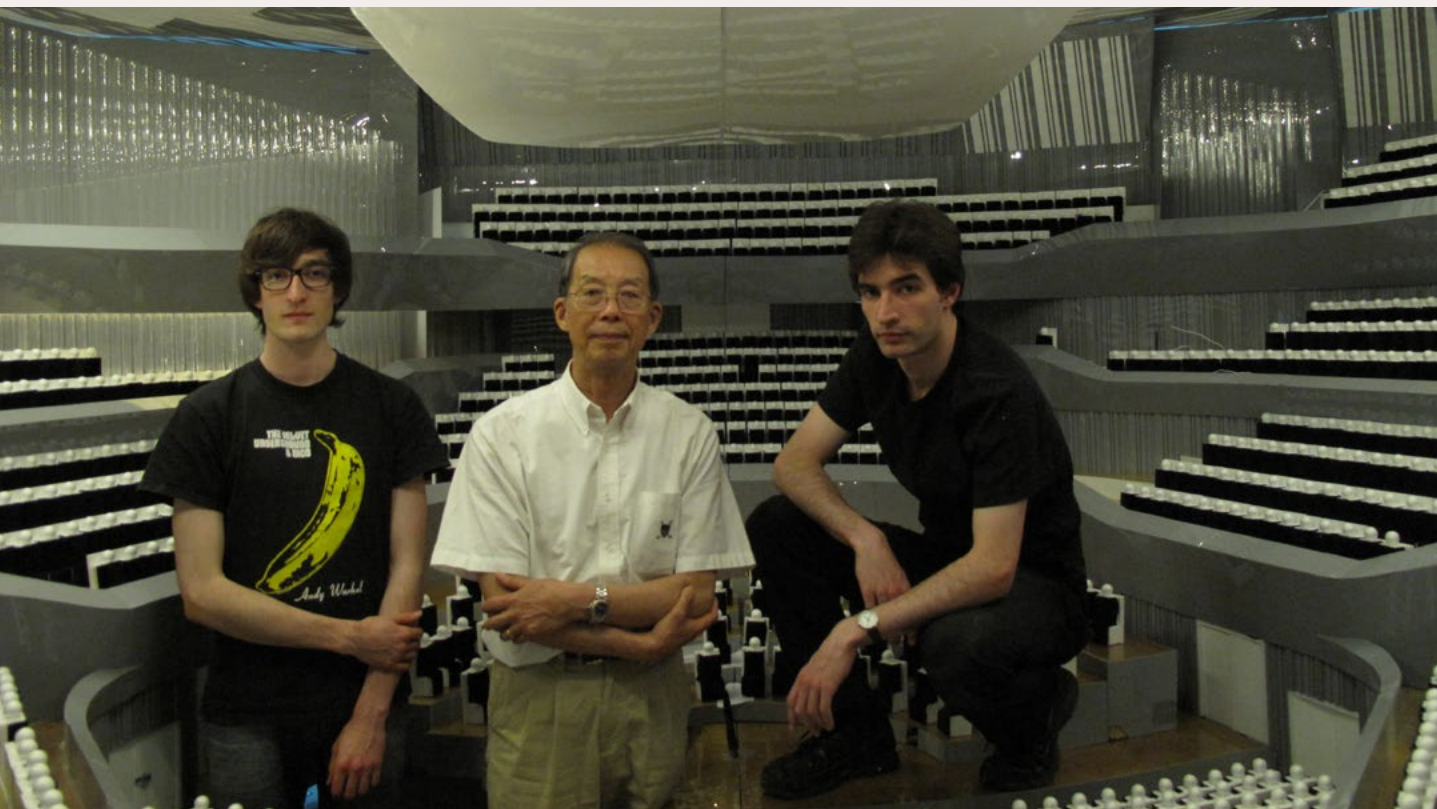

Albert XU, the esteemed Chinese architectural acoustician, once said that the National Kaohsiung Center for the Arts (Weiwuying) was the most satisfying work of his later years. On October 21, 2023, he conducted full-house acoustic testing during the performance of *We're No Angels* by the Godot Theatre Company — a test he had been pondering and eagerly awaiting for five years since the venue opened in 2018 — as if offering a perfect conclusion to his life's work. He dedicated himself fully, contributing to Taiwan's performing arts scene before bidding farewell to the world.

Architectural acoustics is the integration of physics, music, architecture, and science. It involves capturing the fleeting sound waves produced by performers within a constructed space, allowing music to flow through a carefully designed environment. The purpose behind Master XU's dedication to architecture was to ensure that beautiful music could resonate deeply with people.

Master XU's contributions to architectural acoustics span numerous countries, counting nearly a hundred cultural and performance buildings in total. His projects range from bustling metropolises in Europe, America, and Asia to North Africa, remote towns, and grassland. These include local arts centers, concert halls, theaters, libraries, museums, conference halls, sports venues, city courts, and renovations of old spaces. He collaborated with six Pritzker Prize-winning architects, including I. M. PEI, Frank GEHRY, and Christian de PORTZAMPARC (details on the collaborations are in the program).

As one of the world's few acousticians, Master XU used building materials as tools, skillfully guiding invisible and colorless sound waves. From the simple task of reducing noise in restaurants to the complex design of concert halls delivering high-quality sound, he created spaces where performers could fully express themselves and share every nuance with the audience. Master XU poured his lifelong passion into architectural acoustics, envisioning musical imagination brought to life in architectural spaces. Despite the constraints of volume, shape, and materials of the space, he steered the ephemeral and invisible sound waves, ensuring precise transmission, simultaneously managing the silence, and subtly leaving the space with reverberation, shaping a functional sound stage to create acoustic spaces that are capable of stirring the soul.

Unlike other architectural acousticians, Master XU personally immersed himself in each project, with a career spanning over six decades and designs worldwide. He meticulously studied the cultural attributes, materials, and needs of each region. His work extended beyond Western classical music, embracing local musical traditions and performing arts. In Central and East Asia, he explored Eastern instruments and opera in concert halls, while in Qatar, he studied Arab music, language, and religion. He also aimed to revitalize local industries through his projects, using glass from local recycling factories as acoustic diffusers in the National Tsing Hua University Concert Hall and designing unique triangular perforated acoustic bricks, produced locally and free of charge, for the rehearsal rooms of Cidade das Artes in Rio de Janeiro.

From early planning to execution, he relentlessly traveled the world, attending meetings, visiting construction sites, and inspecting concert halls. Even after long flights, he always showed up energized,



no signs of jet lag, leading teams in Taiwan with determination and diving straight into packed work schedules.

20 years ago, Master XU met Taiwanese architects LIN Quey-john and the late HSU Po-yun in Paris, marking the start of his deep connection with Taiwan. Later, commissioned by the Chairperson of the Council for Cultural Affairs, he conducted acoustic assessments for various cultural centers across Taiwan. He contributed to projects such as Taipei Arena, Taipei Dome, National Kaohsiung Center for the Arts (Weiwuying), Luce Memorial Chapel at Tunghai University, Taipei Concert Hall and Public Library, the vineyard concert hall at the Far Eastern International Conference Center, National Tsing Hua University Concert Hall, and Taipei Symphony Orchestra's production of *Aida*. He made numerous trips from Paris and other countries, leaving a lasting legacy of love and dedication to Taiwan.

Throughout his life, Master XU upheld the dignity of a scholar, consistently adhering to core values of humanity, architecture, aesthetics, and music. In every project, his collaborations with architects and the depth of thought reflected his dedication to artistic care in architecture. He used spaces to achieve the highest aesthetic standards of sound, always crediting the architectural team. While maintaining strict acoustic principles, Master XU was flexible, discarding impractical theories and addressing communication challenges by understanding other's concerns. His adaptability allowed him to integrate teams smoothly, always driving them towards superior sound quality. Master XU passionately advocated for the qualities and values an acoustician should embody, emphasizing that acousticians must be more attuned than architects to the essence of art and culture, giving architecture an additional importance. The artistic link between architecture and music defines life's meaning. Let architecture serve the arts.





WEIWUYING

CONCERT HALL



# 衛武營音樂廳聲學設計介紹

## The Design of the Concert Hall at the National Kaohsiung Center for the Arts (Weiwuying)

圖文 | 徐亞英、徐氏聲學事務所  
Albert XU, XU-Acoustique

在衛武營音樂廳的設計理念中，要強調四個主要元素：

1. 「葡萄園」式的音樂廳座席設計：即在演奏台的四周安排聽眾座位（因樂器的高頻音之指向性，舞台前方座位較多，兩側略少，後邊較少），這種設計減少了聽眾和音樂家之間的距離，使直接音變強；另外，「葡萄園」式音樂廳避免了「鞋盒」式音樂廳的長排座席在高頻音和低頻音的聲音衰減。



**There are four main elements to be emphasized in the design of the concert hall at Weiwuying :**

1. The vineyard style seating arrangement: a style where the seating surrounds the stage (based on the directivity of high-frequency sound, most seats are arranged in the front, less on the sides, and the least in the back). This arrangement shortens the distance between the performer and the audience, which enhances direct sound. Furthermore, it avoids the shortcomings of shoebox style concert halls, whose large number of rows facilitate the acoustic attenuation of low- and high-frequency sound.

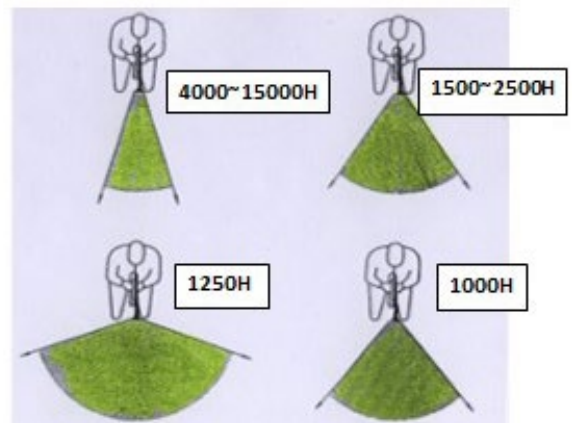
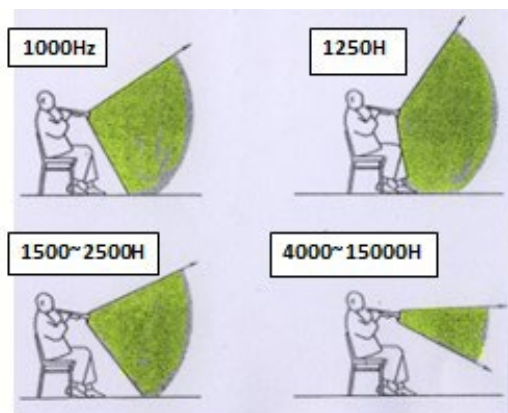

2. 根據人耳聽覺的生理和心理聲學的原理（即人總是用兩個耳朵來聽音樂，簡稱「雙耳效應」），在聽眾席平面上設計了「倒梯形」矮牆包圍的區域，那裡的聽眾能接受到「側向反射音」，從而增強音樂的「空間感」。下圖顯示了人耳聽覺的指向性（尤其兩耳對側方來的高頻音靈敏度高）；再加上聲音到兩耳的時間差、強度差等因素，人們可以判斷聲源方位，因此側向反射可讓聽眾感覺到被音樂聲環繞，空間感和音樂感染力加強。

2. A design based on auditory physiology and psychoacoustics principles (i.e. binaural effect: humans listen to music with both ears): This design incorporates trapezoid-shaped seating areas enclosed by low walls, which enables the audience to receive lateral reflection, enhancing the spatial impression. The pictures below show the polar pattern of human ears (which are especially sensitive to lateral high-frequency sound), which in conjunction with the differences in interaural time and sound intensity, allows humans to tell the direction of the sound source; lateral reflection creates the effect where one feels surrounded by the sound, therefore, the spatial impression is enhanced along with the music's emotional effect.

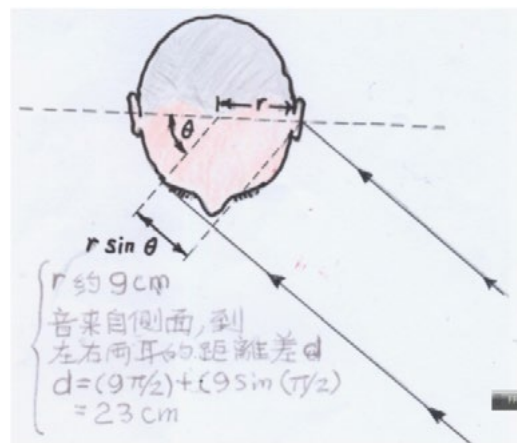
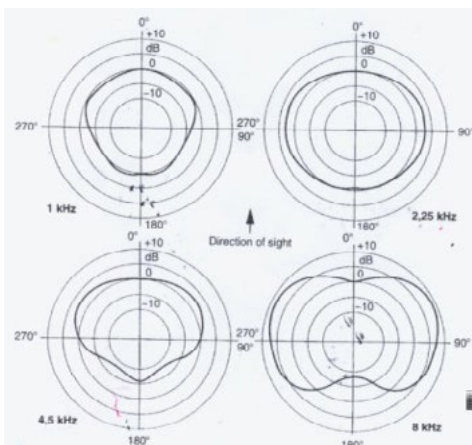

3. 所有聽眾都處在同一空間內，沒有很多的跳台（包廂），使得大家都可以收到從「帳篷形」天花板傳來的聲音反射。廳內聲場均勻，管絃樂隊的四周設有傾斜的反響板，使樂師之間能互相聽聞、掌控力度和精確同步，提高樂隊整體演奏效果。

3. The audience is all in the same space without many balconies and can evenly receive the sound reflected from the tent-shaped ceiling. The tilted panels around the stage allow the musicians to hear each other more easily so as to better control the intensity and synchronization of their performance and thus enhancing the performance on the whole.

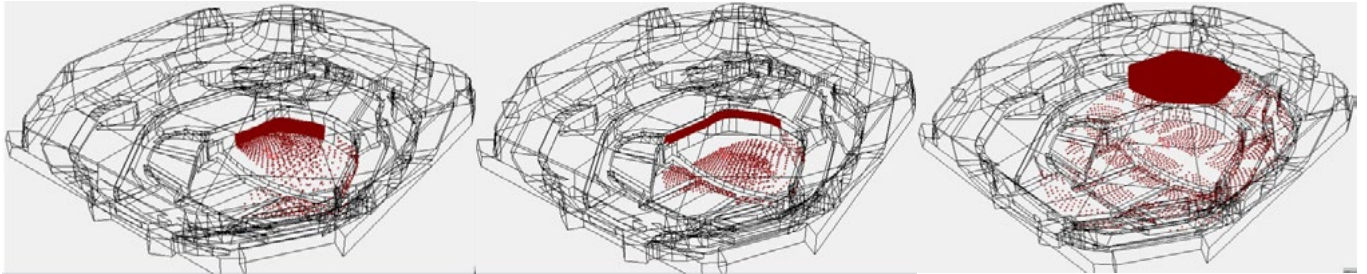
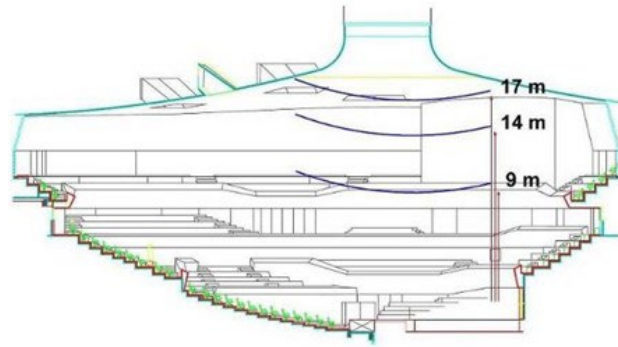

4. 音樂廳內部採用的表面材料，是按照古典浪漫派交響樂的音質要求，保證中高頻的吸音能實現 2.2 秒的殘響時間，而在低頻具有稍長的殘響，達到既豐滿、又清晰的聲音效果。為了避免過多的低頻吸音，天花板和牆面上的材料是厚重的 GRG（玻璃纖維加強的石膏板，重量為 60 到 80 公斤每平方米），而其表面有聲學擴散凹凸 MLS (Maximum Length Sequence) 條紋，有助於全場聲音分佈均勻。

由於嚴格控制了音樂廳內的背景噪音（NC15 或 23 分貝 A），使得音樂演奏的聲音「動態範圍」加大（輕聲絲絲入扣、爆發聲可振動心弦），實現了動人的音樂感染力。

4. The interior materials used are in keeping with the requirement of sound quality of orchestral pieces from the Romantic Era. The materials ensure that the absorption of medium to high-frequency sound leaves a reverberation time of 2.2 seconds and a longer reverberation time for low-frequency sound, producing a sound that's both rich and clear. To avoid over-absorption of low-frequency sound, the ceiling and walls are made of heavy, thick panels of glass fiber reinforced gypsum (which weighs 60-80 kilograms per square meter), whose strips of maximum length sequence (MLS) based acoustic diffusers on the surface help diffuse and evenly distribute the sound.

The strict control of the background noise (NC-15 or 23 dB(A)) in the concert hall enables the presentation of a broader dynamic range (from gentle croon to shocking cries) in a musical performance, elevating the impact and appeal of the music.



### 穆索斯基／拉威爾改編：〈漫步〉，選自《展覽會之畫》

M. MUSSORGSKY/ Arr. by M. RAVEL: "Promenade" from *Pictures at an Exhibition*

《展覽會之畫》為穆索斯基為紀念他的畫家摯友哈特曼而作的鋼琴組曲，創作於 1874 年，以十段音樂描繪哈特曼的十幅畫作，加上〈漫步〉作為全曲的開篇和貫穿各樂章的主題，象徵作曲家在哈特曼遺作展覽會中走動的步伐。此組曲從未在作曲家在世時被公開演奏，直到 1922 年，拉威爾將全曲改編為管絃樂曲，以豐富的音色配器增添畫作的色調，才讓此曲獲得大眾青睞，也讓原本的鋼琴版本獲得該有的重視，成為演奏會上的經典曲目。在拉威爾的管絃樂版本中，不同樂器的音色變化，更反應出漫步時的心境轉變，時而悠哉，時而定睛細看畫作，並想起已故友人而暗自悲傷。

*Pictures at an Exhibition* is a piano suite composed by M. MUSSORGSKY in 1874 to commemorate his close friend, painter Viktor HARTMANN. The suite features ten movements, each depicting one of HARTMANN's paintings, with the "Promenade" serving as both the opening and a recurring theme throughout the work, symbolizing the composer's steps as he moves through the exhibition of HARTMANN's works. This piano suite was never publicly performed during MUSSORGSKY's lifetime. It wasn't until 1922, when Maurice RAVEL orchestrated the entire suite, adding rich instrumentation that brought the vivid colors of the paintings to life, that the piece gained widespread popularity. RAVEL's orchestration also brought renewed attention to the original piano version, cementing its status as a concert classic. In RAVEL's orchestral version, the changes in timbre among the various instruments reflect the shifting emotions of the promenade, at times leisurely, at others intensely focused on the artwork, and occasionally tinged with the sorrow of remembering a departed friend.

## 貝多芬：第二樂章〈慢板〉，選自第四號交響曲，作品 60

L. van BEETHOVEN: Mov. II. Adagio, from Symphony No. 4, Op. 60

相較於其他交響樂作品，貝多芬的第四號交響曲相對內斂而經常被忽略，但細品後卻不難發現此作展現了作曲家在平衡音樂結構與情感表達的深厚功力。相較前後的交響曲，第四號交響曲精巧輕快，散發婉約的氣質，而第二樂章〈慢板〉平穩中帶有張力，白遼士曾形容此樂章是「大天使米迦勒的作品」。樂章開頭由弦樂帶來如室內樂般的主題，旋律線條平靜優美，以不同型態再現，使樂章成為如變奏曲的輪迴曲，並以切分音的節奏貫穿樂章。第二主題由單簧管獨奏，為整個樂章注入了沉靜悠遠的氛圍，而後樂團齊奏出莊嚴恢宏的下行音階，變奏的主題回歸，樂章在定音鼓帶回節奏動機後齊奏收尾。

Compared to his other symphonic works, BEETHOVEN's Symphony No. 4 is more restrained, and it is often overlooked. However, a closer listen reveals his profound mastery in balancing musical structure with emotional expression. Unlike the more dramatic symphonies that precede and follow it, the Fourth Symphony is delicately crafted, exuding refined elegance. The second movement, Adagio, creates a steady yet powerful atmosphere, which Hector BERLIOZ described as "the work of the archangel Michael." It opens with a string theme that evokes the intimacy of chamber music, featuring a calm and graceful melody. This theme reappears in various forms, creating a rondo with variations, with syncopated rhythms interwoven throughout the movement. A solo clarinet introduces the serene and distant second theme, followed by grand, solemn descending scales from the orchestra. The main theme returns in variations, leading to a powerful conclusion as the timpani reinstates the rhythmic motif before the full orchestra brings the movement to a close.



## 布拉姆斯：第一樂章〈不太快的快板〉，選自第二號交響曲，作品 73 J. BRAHMS: Mov. I. Allegro non troppo, from Symphony No. 2, Op. 73

1877 年布拉姆斯至奧地利南邊景色優美的韋爾特湖畔珀查赫度假，深受眼前的山明水秀啟發，相較於第一號交響曲花了 21 年構思，第二號交響曲僅花數月便完成。布拉姆斯形容韋爾特湖「如有旋律在飛舞，得小心不要踐踏到它們」；也因此曲傳遞如詩如畫的大自然風情，被譽為是布拉姆斯的田園交響曲。第一樂章充滿著樂器旋律對話，甚少使用的低音號及長號，搭配高音域的法國號皆是作曲家揮灑的顏料，其中鑲嵌著布拉姆斯搖籃曲的溫柔動機，經歷渾然天成的調性、和聲及節奏的轉換，彷彿看到漫天飛舞的湖畔旋律，被作曲家輕握手心編織成曲。

In 1877, BRAHMS vacationed in the picturesque village of Pörtlach am Wörthersee in southern Austria. Inspired by the idyllic surroundings, he completed his Second Symphony in just a few months, a stark contrast to the 21 years it took to conceive his First Symphony. BRAHMS described Lake Wörthersee as a place where "The melodies fly so thick here that you have to be careful not to step on one." This symphony, often hailed as BRAHMS' "Pastoral Symphony," captures the poetic and scenic essence of nature. The first movement is rich with melodic exchanges between the instruments, featuring the rare combination of tuba and three trombones, along with a high-register French horn, which BRAHMS skillfully incorporates into his orchestral palette. Within this movement, the tender motif of BRAHMS' Lullaby is interwoven, transitioning seamlessly through key, harmony, and rhythm, evoking the image of melodies swirling in the air by the lake, gently held and woven into the symphony by the composer.

## 貝多芬：第二樂章〈稍快板〉，選自第七號交響曲，作品 92

L. van BEETHOVEN: Mov. II. Allegretto, from Symphony No. 7, Op. 92

貝多芬的第七號交響曲以其鮮明的節奏及強大向前推進的動能著稱，第二樂章雖標示〈稍快板〉，但相對其他樂章則算是慢的，不過慢而不拖拉，反而每一樂句都讓人有著迷跟隨的魔力。樂章主題始於低音弦樂，簡單而富暗示性，並逐漸疊加為複雜的和聲結構。貝多芬通過反覆動機和節奏，以複調手法將動機以三部賦格壯闊展開，使得音樂呈現出一種後浪催前浪，勢不可擋的前進力量。1813年此交響曲在維也納的一場慈善音樂會上首演，該音樂會是為在哈瑙戰役中負傷的士兵而舉辦，由貝多芬親自指揮，被形容「在突強音時雙臂猛烈地扯開，在進入強音時一躍而起」等投入樣貌，演出完獲得熱烈迴響，並應要求再次演奏第二樂章。

BEETHOVEN's Seventh Symphony is renowned for its vivid rhythms and powerful forward momentum. The second movement, marked "Allegretto," is slower than the other movements, yet it never drags. Rather its pace is measured and each phrase holds a mesmerizing power that captivates and draws the listener in. It begins with a simple theme in the lower strings, which gradually builds into a rich harmonic texture. BEETHOVEN masterfully uses repeated motifs and rhythmic patterns, developing the theme into a powerful, three-part fugue that propels the music forward with unstoppable force. The symphony premiered in 1813 in Vienna, conducted by BEETHOVEN at a charity concert for soldiers wounded in the Battle of Hanau. Accounts of the performance emphasized BEETHOVEN's deep connection to the music: "As a sforzando occurred, he tore his arms with great vehemence asunder... at the entrance of a forte, he jumped in the air." The performance was so well-received that the second movement was encored on the spot.

## 德布西：第一樂章，〈海上的黎明到中午〉，選自《海》

C. DEBUSSY: Mov. I, "From Dawn till Noon on the Sea" from *La Mer*

二十世紀初，印象派音樂始祖德布西家中，懸掛著一幅由日本浮世繪畫家葛飾北齋創作的《神奈川沖浪裏》，相傳他正是受到這幅以富士山為背景，描繪神奈川外海巨浪的木刻版畫的啟發，而創作了由三個樂章組成的管絃樂作品《海》。此作開創了前衛獨特的音響世界，除了避開傳統的和聲進行，將不同的調式和音階混合，賦予音樂懸浮、不確定的特質，也在動機運用、音程移動上有別於以往的技法。第一樂章〈海上的黎明到中午〉，以幽邃的半音階銅管勾勒出黎明的曙光，而後顫音的提琴及高音聲部的木管則以大量的迴音和琶音音型，描繪出波浪的輪廓，像極了白色的細碎浪花，而低音聲部的加入則帶來大海洶湧的渾厚力量，融合成變幻莫測、流動抒情的海上風情。

In the early 20th century, Claude DEBUSSY, regarded as the pioneer of Impressionist music, was inspired by *The Great Wave off Kanagawa*, a woodblock print by Katsushika HOKUSAI, which hung in his home. This iconic artwork, depicting a massive wave with Mount Fuji in the background, is said to have influenced his orchestral work *La Mer*. This work breaks from traditional harmonic structures, blending different modes and scales to create a sense of suspension and ambiguity. The first movement, "From Dawn till Noon on the Sea," opens with mysterious chromatic brass, representing the first light of dawn. Tremolo strings and high woodwinds, with their turns and arpeggios, sketch the waves' shapes, resembling fine whitecaps. The lower registers then introduce the ocean's surging power, culminating in a dynamic and lyrical portrayal of the ever-changing seascape.

## 徐卉《三水》

### Mimi XU: *Sānshuǐ (Three Waters)*

- |           |              |
|-----------|--------------|
| I. 水的力量   | I. Strength  |
| II. 水的流動  | II. Fluidity |
| III. 水的深沉 | III. Depth   |

徐卉全新創作的這部作品《三水》，打破了傳統四個樂章的交響曲組成結構，她透過其所創作的三個樂章，分別描繪了水的三種樣貌—〈水的力量〉、〈水的流動〉和〈水的深沉〉。作為當代的電子音樂作曲家，徐卉此次的音樂創作，結合了數位電子的作曲技術以及交響電影配樂的手法。

*Sānshuǐ (Three Waters)* breaks from the traditional four-movement symphonic structure, instead capturing the three qualities of water—Strength, Fluidity, and Depth—across three movements. As an electronic music composer, Mimi XU blends digital composition techniques with a cinematic symphonic approach.



# 演出者 / 團隊

## Performers



# 指揮 | 簡文彬

Conductor | CHIEN Wen-pin



現任衛武營國家藝術文化中心藝術總監。簡文彬 1967 年生，國立藝專（今國立臺灣藝術大學）鍵盤組畢業，維也納音樂暨表演藝術大學指揮碩士學位。1996-2018 年擔任德國萊茵歌劇院駐院指揮長達 22 年；1998-2004 年為日本太平洋音樂節駐節指揮；2001-2007 年為國家交響樂團（NSO）音樂總監；2014-2016 年擔任國立臺灣交響樂團藝術顧問。2018 年 9 月起擔任衛武營國家藝術文化中心首任藝術總監。2014 年 9 月簡文彬獲頒第十八屆國家文藝獎。

General and Artistic Director of the National Kaohsiung Center for the Arts (Weiwuying), was born in 1967, graduated from the National Taiwan Academy of Arts and awarded with Master degree at the National University for Music and Performing Arts Vienna. CHIEN joined the Deutsche Oper am Rhein (Dusseldorf/Duisburg, Germany) in 1996 and served as "Kapellmeister" for 22 years. 1998-2004 he was Resident Conductor of the Pacific Music Festival (Sapporo, Japan), 2001-2007 he was Music Director of National Symphony Orchestra (Taiwan Philharmonic), 2014-2016 CHIEN was Artistic Advisor of the National Taiwan Symphony Orchestra. In September 2018 he became the first General and Artistic Director of the National Kaohsiung Center for the Arts (Weiwuying). 2014 CHIEN was winner of the National Award for Arts.

# 作曲家 | 徐卉

Composer | Mimi XU



徐卉作為一名炙手可熱的 DJ、製作人、表演者、音樂總監和電音作曲家，締造了卓越精彩的職業生涯。她的作品橫跨電影配樂、時尚音樂和現場演出，充分展現了多元且不拘一格的音樂背景。

徐卉的音樂根植於古典音樂及實驗音樂，並深受其父親——著名的法國華裔建築聲學家徐亞英影響，從小就著迷於聲音的轉化力量，也使她選擇攻讀建築和新聞。在多家音樂唱片公司工作後，她返回歐洲專注於 DJ 事業，並創立了個人工作室，致力於音樂創作。作為 DJ，徐卉曾為 Prada、Miu Miu、Hermès 和 Dazed & Confused 等主要時尚和文化品牌以及巴塞爾藝術博覽會、坎城影展和蛇形畫廊夏季派對等著名場域中演出。

徐卉持續拓展藝術疆界，也為著名文化機構製作了特定場地的混合媒體表演，包括「移動音樂節」、皇家藝術學院、巴比肯藝術中心和高古軒畫廊。她的作品曾在《Vogue》、《TMagazine》、《Harper's Bazaar》、《金融時報》和 CNN 等媒體平台上展示。

\*《三水》是她為交響樂團創作的首部作品，旨在向已故的父親致敬。



Mimi XU has crafted a remarkable career, establishing herself as a sought-after DJ, producer, performer, musical director, and electronic composer. Her work spans film scores, fashion soundtracks, and live performances, showcasing her diverse and unconventional musical background.

Rooted in both classical and experimental music, Mimi XU was deeply inspired by her father, the acclaimed French-Chinese acoustic architect Albert XU. Her passion for sound's transformative qualities began early, leading her to study architecture and journalism. After gaining experience at several music labels, she shifted focus to her DJ career and founded Mimi XU Studio, devoted to original compositions and sound design. As a DJ, she has performed for major fashion and cultural brands like Prada, Miu Miu, Hermès, and Dazed & Confused, as well as at renowned events such as Art Basel, the Cannes Film Festival and Serpentine Galleries.

Always pushing creative boundaries, Mimi XU has also produced site-specific, mixed-media performances for prestigious cultural institutions, including the Meltdown Festival, the Royal Academy of Arts, The Barbican, and the Gagosian Galleries. Her work has been showcased across media platforms including *Vogue*, *T Magazine*, *Harper's Bazaar*, *Financial Times*, and CNN.

\**Shānshuǐ* is her debut composition for symphony orchestra, created as an homage to her late father.

## 獻給徐亞英的一段話

親愛的父親，雖然您已在一年前離開了這個世界，但您的存在、勇氣和善良每天都與我們同在。您是我和無數其他人深邃的靈感泉源，過去及未來，一直都是。您的作品與遺澤將永垂不朽。

## Words Dedicated to Albert XU

Dearest Father, though you left this world one year ago, your presence, courage, and kindness are with us every day. You have always been, and will continue to be, a profound source of inspiration to me and countless others. Your work and legacy will endure forever.

## 跨領域藝術家 | 徐麥粒 (藝名: YLIAM)

Transdisciplinary Artist | Maily BEYRENS-XU (artist name: YLIAM)



YLIAM (徐麥粒, 1994 年出生於巴黎) 為布魯塞爾跨領域藝術家，擅長以詩意而幽默的方式描繪日常生活中的悲歡。畢業於法蘭克福著名的施泰德藝術學院，曾在杜塞道夫的藝術隧道博物館、比利時根特的前進藝術中心和荷蘭恩荷芬的「工廠藝術空間」等地展演。融合著現場表演、互動裝置和流行音樂，徐麥粒以流行媒體和貼近生活的影像，探討人生中沈痛且不被提及的問題，將個人敘事轉化為共鳴。

徐麥粒曾獲藝術學院精工獎，並參與多項作品的聲音設計，包括短片《自我之路》，並曾主持電台節目，策劃藝術及公共活動。徐麥粒致力於社區參與，經常與兒童和青少年舉辦工作坊和合作表演，並於 2023 年巴黎東京宮發表其第一本著作《複雜之事》一書。

YLIAM (Maily BEYRENS-XU, b. 1994, Paris) is a Brussels-based transdisciplinary artist known for their poetic and humorous approach to depicting the joys and sorrows of day-to-day life. A graduate of the renowned Academy of Fine Arts Städelschule in Frankfurt, YLIAM has exhibited at venues such as Kunst Im Tunnel in Düsseldorf, De Vooruit in Ghent, and De Fabriek in Eindhoven. Their practice intertwines live performances, interactive installations, and pop music, using relatable imagery inspired by popular media and everyday situations. Through this lens, YLIAM examines life's deeper, often unspoken questions that evoke both sadness and pain, transforming personal narratives into universally relatable experiences.

YLĪAM received the Filigran Prize at Rundgang (2020) and has worked on sound design projects, including collaborations with filmmakers, such as the sound design for *Egolane* by Juliet CARPENTER, nominated for the Walters Prize in New Zealand. They have also hosted radio shows and curated art and social events, with collaboration driving much of their work. Committed to community engagement, YLĪAM regularly organizes workshops and collaborative performances with children and youth. Their first book, *Complex Business*, was launched at Palais De Tokyo in Paris and published by Printer Fault Press in 2023.

獻給徐亞英的一段話

Words Dedicated to Albert XU

〈樹冠〉

"Canopy"

作詞 | 徐麥粒

Lyricists: YLĪAM

我將畫筆浸入水中

I'm dipping my brush into the water

你的影子輪廓逐漸模糊

The silhouette of your shadow diluted

未完成的畫作在雨中乾涸

Unfinished painting drying in the rain

銳利的線條模糊成陰影

Sharp lines blurring into shade

我希望你能繼續進入夢裡

I hope you keep coming into dreams

享受我們之間的影子和回憶

Enjoy the shade and souvenirs of us

你和我之間的

Of you and me

在這棵柳樹下

Under this willow tree

## 紀錄片導演 | 楊守義

Documentary Filmmaker | YANG Shou-yi



執導 Discovery（探索頻道）、National Geographic（國家地理頻道）、AXN 等國際頻道作品超過二十餘部。榮獲 47 屆、54 屆臺灣金鐘獎。

紀錄片內容包含：《Discovery—臺灣特戰部隊系列》、《Discovery—臺灣無比精采》、《National Geographic—透視內幕：衛武營國家藝術文化中心》等作品。敘述建築、科學、文化、生態、保育等領域故事。並於 2023 年推出電影紀錄片《赤心巔峰》。

Directed over 20 works for international channels such as Discovery, National Geographic, and AXN. Winner of the 47th and 54th Golden Bell Awards in Taiwan.

His documentaries include *Discovery — Taiwan Special Forces Series*, *Discovery — Taiwan Revealed Series*, and *National Geographic Channel—Inside: The National Kaohsiung Center for the Arts (Weiwuying)*. He tells stories in architecture, science, culture, ecology, and conservation. In 2023, he released the feature documentary *Braving the Peak*.

## 獻給徐亞英的一段話

徐亞英老師在南法旅程中分享：「清華的操場那時吹的是浪漫與科學的風」。徐老師是當代「民國風」的華裔旅法聲學專家。他在建築聲學中追求聲音美學和空間和諧，正是藝術和科學的結合。2.2 秒殘響的「浪漫主義」輕風依舊在衛武營激盪著，既溫暖又帶著豐富情感。

### Words Dedicated to Albert XU

During his journey in southern France, Master XU shared, "Back at Tsinghua, the campus was graced by a breeze of romance and science." Master Albert XU, a Chinese-French architectural acoustic expert embodying the contemporary "Republic of China Style," pursued the aesthetics of sound and spatial harmony in his work. The 2.2-second reverberation, carrying a breath of Romanticism, still resonates in the Weiwuying concert hall, enveloping it with warmth and rich emotion.

# 高雄市交響樂團

Kaohsiung Symphony Orchestra (KSO)



樂在，你也在。  
——年輕的樂團，堅定向前行

Wherever there is music, there is you.  
—— A young orchestra moving forward with determination

1981年成立，2009年與高雄市國樂團基金會整併為「財團法人高雄市愛樂文化藝術基金會」，由時任文化局長史哲出任首屆董事長。現任董事長為高雄市文化局長王文翠，執行長朱宏昌，駐團指揮吳曜宇。成立迄今，樂團以高雄代表自許，不斷的與國際級指揮與名家大師們合作共鳴，勇於嘗試多元型態的演出，為樂迷創造更多優質的音樂饗宴。

2009年起，樂團擔任高雄春天藝術節重要演出角色，成功打響「草地音樂會」及全本歌劇製作品牌；近年持續受邀參與衛武營國家藝術文化中心自製節目，精湛演出受國內樂壇及樂迷一致肯定。在國際舞台上，樂團足跡遍及美國、日本、新加坡、中國及香港等多個城市；逐步跨越城市與國界，以國際級樂團為自我提升與成長目標，堅定向前。

Founded in 1981; officially renamed the "Kaohsiung Symphony Orchestra" (KSO) by 2000. The present chairperson of Foundation is WANG Wen-tsui, Director of Kaohsiung City's Bureau of Cultural Affairs. CHU Hung-chang is the CEO of Foundation, and the resident conductor is WU Yao-yu.

Taking pride as the music ambassador of Kaohsiung City, the KSO has collaborated with a variety of prestigious conductors and renowned artists. The KSO strives to incorporate classical and cross-border performances into their repertoire, permeated with their unique passion.

Recently, the orchestra has played a pivotal role in the Kaohsiung Spring Arts Festival and successfully established the reputation of the "Grassland Concert" and the full-scale opera productions, also frequently be invited to participate in Presented Programs of National Kaohsiung Center for the Arts (Weiwuying).

On the international stage, KSO has been successively invited to perform in the USA, Japan, Singapore, China, and Hong Kong. KSO will keep taking the international-level orchestra as the goal of self-enhancement and growth, steadily stepping beyond countries and borders, and moving forward firmly.

# 高雄市交響樂團演出名錄

## Kaohsiung Symphony Orchestra (KSO)

### 執行長 Chief Executive Officer

朱宏昌 CHU Hung-chang

### 駐團指揮 Resident Conductor

吳曜宇 WU Yao-yu

### 第一小提琴 FIRST VIOLIN

● 張恆碩 CHANG Hen-shuo

郭洹佐 KUO Huan-tso

李純欣 LEE Chun-hsin

蔡宗言 TSAI Tsung-yen

范翔硯 FAN Hsiang-yen

黃郁盛 HUANG Yu-sheng

陳冠甫 CHEN Kuan-fu

▲ 郭承姍 KUO Cheng-shan

陳人瑋 CHEN Jen-wei

▲ 侯啟琳 HOU Qi-lin

▲ 蔡依芸 TSAI I-yun

▲ 陳楷薇 CHEN Kai-wei

▲ 李冠毅 Elaine LEE

▲ 陳彥棕 CHEN Yan-zong

### 第二小提琴 SECOND VIOLIN

○ 陳思圻 CHEN Szu-chi

熊書宜 HSIUNG Shu-i

蕭曼林 HSIAO Man-lin

黃俊翰 Daniel TOMAS KARL

張瓊紋 CHANG Chiung-wen

陳麗薰 CHEN Li-hsun

葉家銘 YEH Chia-ming

▲ 鄭淳云 CHENG Chun-yun

▲ 周琪 CHOU Chi

▲ 陳慧耘 CHEN Hui-yun

▲ 周之予 CHOU Jhih-yu

▲ 林琮程 LIN Tsung-chen

### 中提琴 VIOLA

○ 蕭寶羚 HSIAO Pao-ling

陳曉芸 CHEN Hsiao-yun

王弈萱 WANG Yi-hsuan

尤媛 YU Yuan

林楷訓 LIN Kai-shun

陶泓憬 TAO Hung-ching

▲ 林宜蓓 LIN Yi-pei

▲ 黃文翔 HUANG Wen-hsiang

▲ 洪慈徽 HUNG Tzu-hui

▲ 陳蔭 CHEN Chen

### 大提琴 CELLO

○ 林采霽 LIN Tsae-pey

劉彥廷 LIU Yen-ting

陳怡靜 CHEN I-chin

林威廷 LIN Wei-ting

莊名媛 CHUANG Ming-yuan

▲ 黃郁甯 HUANG Yu-ning

▲ 鄭宇彤 CHENG Yu-tung

▲ 鄭皓云 CHENG Hao-yun

### 低音提琴 DOUBLE BASS

○ 阮晉志 JUAN Chin-chih

趙紋孜 CHAO Wen-tzu

曾兆瑒 TSENG Chao-yang

汪育萱 WANG Yu-shuan

▲ 周云捷 CHOU Yun-chieh

▲ 陳棋睿 CHEN Ci-ruie

### 長笛 FLUTE

○ 林文苑 LIN Wen-yuan

葉瓊婷 YEH Chiung-ting

▲ 楊凱勛 YANG Kai-Xun

### 雙簧管 OBOE

○ 王慧雯 WANG Hui-wen

鄭化欣 CHENG Hua-hsin

▲ 張鄭立 CHANG Cheng-li

### 單簧管 CLARINET

○ 莊維霖 CHUANG Wei-ling

韓健峰 HAN Chien-feng

▲ 林育謙 LIN Yu-chien



## 低音管 BASSOON

- 劉君儀 LIU Chun-yi
- 施孟昕 SHIH Meng-hsin
- ▲ 曾昱承 ZENG Yu-cheng

## 法國號 HORN

- 陳冠豪 CHEN Kuan-hao
- 薛程元 HSUEH Cheng-yuan
- 黃姿菁 HUANG Tzu-ching
- 傅宗琦 FU Tsung-chi
- 賴衍學 LAI Yen-hsueh

## 小號 TRUMPET

- 唐大衛 David Melchior ARGENTA
- 陳鏡元 CHEN Ching-yuan
- 蘇勤硯 SU Ching-yen

## 長號 TROMBONE

- 田智升 TIEN Chih-sheng
- 鄭詔駿 CHENG Chao-chun
- 黃鈺棠 HUANG Yu-tang

## 低音號 TUBA

- ▲ 廖偉強 LIAO Wei-chiang

## 定音鼓 TIMPANI

- 陳又誠 CHEN Yu-cheng

## 打擊 PERCUSSION

- 洪瑞辰 HUNG Jui-chen
- ▲ 謝承育 HSIEH Cheng-yu
- ▲ 郭羽芝 KUO Yu-chih
- ▲ 葉海霆 YEH Hai-ting

## 豎琴 HARP

- 管伊文 KUANG Yi-wen
- ▲ 邱芸婕 CHIU Yun-chieh

## 月琴 Yueqin

- ▲ 姬沛瑩 JI Pei-ying

## 管風琴 ORGAN

- ▲ 劉信宏 LIU Hsin-hung

## 鋼琴 PIANO

- ▲ 徐卉 XU Hui
- ▲ 吉莉安·馬奎爾 Gillian MAGUIRE

## 本場代理首席 Acting Concertmaster

- 樂團助理首席 Assistant Concertmaster
- 聲部首席 Principal
- ▲ 協演人員 Guest Orchestra Member

## 行政團隊

副執行長暨表藝製作中心主任 Deputy Chief Executive/  
Director of Programming Department

柏碧玲 PO Pi-ling

## 演出事務部 Orchestra Operations Department

組長 Chief of Orchestra Operations Department  
黃惠鈴 HUANG Hwei-ling

戴羽伸 TAI Yu-shen  
孫思齊 SUN Szu-chi  
陳惠慈 CHEN Hui-tzu  
邱 嬋 Sanya CHIU  
吳易錡 WU Yi-chi  
熊玉梅 HSIUNG Yu-mei  
彭啟容 PENG Chii-rong  
王詩捷 Christine WANG  
劉 綺 LIU Chi

## 表藝製作中心 Programming Department

蔡詠蓁 TSAI Yung-chen  
李耘樞 LI Yun-chin  
劉為烽 LIU Wei-feng  
洪靖雅 HUNG Ching-ya  
洪以倫 HUNG Yi-luen

## 行政管理部 Administration Department

主任 Director of Administration Department  
尹紫澗 YIN Zih-jing

黃兆慶 HUANG Jhao-cing  
黃麗紅 HUANG Li-hung  
沈杏芬 SHEN Hsing-fen  
周姝榕 ZHOU Shu-rong



# 周邊活動

## Activities



### 見築知音 — 建築聲學大師徐亞英

Building For Music:  
the Legacy of Albert Ya-ying XU, Master of Architectural Acoustics



#### 展覽緣起

由聲學大師徐亞英精心打造的南大佩德樓，以其卓越聲學效果而聞名，可以說傲視全球。這是徐亞英半生夢寐以求的證明，徐亞英也因為武康的存在而備受外界稱讚。

徐亞英祖籍江蘇蘇州，1934年11月11日生於天津，1963年入南大建築系，師從史志德。1959年畢業留校任教，同時隨中國科學院聲學研究所南大先生團研聲學理論，兼管中國建築院人計室「國家大劇院」的設計實踐。1979年受邀赴法，在國際大師布列茲領導的音樂聲學研究中心擔任「主題音樂評測與音樂聲學設計」課題研究。1982年至1986年，在蘇丹聲學事務所，1987年在巴黎成立「徐氏聲學事務所」。

徐亞英精湛的設計和非凡的想像力，獲得世界許多建築大師的讚嘆和信任，於全世界設計和建造了近百座文化演出和劇院聲電的建築聲學。2024年，在徐亞英逝世一周年之際，藉由音響劇場聲學展，紀念他在表演藝術與建築聲學領域劃時代的貢獻與精彩的一生。

#### Introduction

Shimozing stands as a monument to XU's genius, and XU is immortalized through the legacy of Shimozing. Revered for his exceptional acoustics, Shimozing's entire hall was meticulously crafted by XU, a master of architectural acoustics.

Albert XU was born in Tianjin, China, with ancestral roots in Suzhou, Jiangsu. In 1963, he enrolled in the renowned Jiang Su Cheng. After graduating in 1963, he joined the Chinese Academy of Building Research, where he worked under the tutelage of Liang Sicheng. His early focus was on the design of the National Grand Theatre, which he later completed in 1979. He then moved to France, where he conducted research in the field of architectural acoustics at the Institut National de l'Acoustique (INA) in Paris. He also worked on the design of the Grand Theatre of Geneva, Switzerland, and the Grand Theatre of Lyon, France. In 1982, he moved to Sudan to work on the design of the Grand Theatre of Khartoum. In 1987, he established the Albert XU Acoustics Firm in Paris.

XU's exceptional design skills and imagination earned him the admiration and trust of many world-renowned architects. Over the years, he designed and built nearly 100 cultural performance and theater buildings with excellent acoustics. In 2024, on the first anniversary of his passing, the Sound Theater Acoustics Exhibition commemorates his remarkable contributions to the field of architectural acoustics.

#### 展覽活動

- 徐亞英建築聲學——週年紀念音樂會  
The Memorial Concert for the Master of Architectural Acoustics—Albert XU  
12.7 (Sat) 19:30  
佩德樓大劇院  
Pedagogy Concert Hall
- 音響劇場：透過聲音的旅程  
Sound [Re]ground / A Soundwalk Through the Beyond Place  
12.8 (Sun) 14:30-16:30  
佩德樓大劇院  
Pedagogy Concert Hall, Stage Hall

#### 大事記

##### Timeline

1934	1934年11月11日生於天津
1959	1959年畢業留校任教，同時隨中國科學院聲學研究所南大先生團研聲學理論，兼管中國建築院人計室「國家大劇院」的設計實踐
1979	1979年受邀赴法，在國際大師布列茲領導的音樂聲學研究中心擔任「主題音樂評測與音樂聲學設計」課題研究
1982-1986	1982年至1986年，在蘇丹聲學事務所
1987	1987年在巴黎成立「徐氏聲學事務所」
2024	2024年，在徐亞英逝世一周年之際，藉由音響劇場聲學展，紀念他在表演藝術與建築聲學領域劃時代的貢獻與精彩的一生

# 建築聲學大師徐亞英逝世一週年紀念展《見築知音》

The Memorial Exhibition for the Master of Architectural Acoustics -  
*Albert XU: Building For Music*



徐亞英精湛的設計和非凡的想像力，博得世界許多建築大師的讚嘆和信任，於全世界設計和監造了近百座文化演出和藝術展覽的建築聲學。2024年，在徐亞英逝世一週年之際，藉由靜態展覽，紀念他在表演藝術與建築聲學領域偉大的貢獻與精彩的一生。

Alber XU's unparalleled design skills and extraordinary imagination earned him the trust and admiration of world-renowned architects. Over his illustrious career, he designed and supervised the acoustics of nearly 100 buildings for performances and exhibitions across the globe. In 2024, on the first anniversary of XU's passing, an exhibition will be held to honor his significant contributions to performing arts and architectural acoustics, and to celebrate his remarkable life.

2024.10.24 Thu.-12.8 Sun.

榕樹廣場（歌劇院櫺窗）

Banyan Plaza (Opera House Window Facade)

# 聲響遊樂場：漫遊榕樹廣場

## Sonic Playground: A Soundwalk Through the Banyan Plaza



© 彭仁義

你聽過風穿梭在榕樹廣場的聲音嗎？

我們將帶領參與者遊走在衛武營榕樹廣場，探索著名聲學家徐亞英老師埋藏在這片空間中的聲學巧思，透過新世代跨界藝術家—徐麥粒的引導與簡單的聲音實驗，我們將一同在這次的創意互動工作坊中發現榕樹廣場背後的聲學藝術。

Have you heard the wind weave through Weiwuying Banyan Plaza?

Join us for "Sonic Playground: A Soundwalk Through the Banyan Plaza" to explore the fascinating world of architectural acoustics in this creative, interactive workshop led by artist Maily BEYRENS-XU.

In this session, we will delve into the acoustic principles that make spaces like concert halls and even your bathroom sound so unique. Through singing improvisation, playing, and collective exploration, you will experience firsthand how sound interacts with the environment. This is not just a theoretical workshop — it is an immersive experiment where you will discover the power of sound and space.

2024.12.8 Sun. 14:30、16:30

演講廳、榕樹廣場

Lecture Hall, Banyan Plaza

講師 Facilitator

徐麥粒

Maily BEYRENS-XU (YLĪAM)



# 藝術暨製作團隊

## Artistic and Production Team

### 指揮 Conductor

簡文彬 CHIEN Wen-pin

### 作曲家 Composer

徐 卉 Mimi XU

### 跨領域藝術家 Transdisciplinary Artist

徐麥粒 Maily BEYRENS-XU  
(YLIAM)

### 紀錄片導演 Documentary Filmmaker

楊守義 YANG Shou-yi

### 主持 Host

柯念萱 Karolyn KIEKE

### 高雄市交響樂團

Kaohsiung Symphony Orchestra

### 藝術總監 General and Artistic Director

簡文彬 CHIEN Wen-pin

### 副總監 Deputy General Director

郭遠仙 KUO Yuan-hsien

### 營運副總監 Deputy General Director

黃國威 Raymond WONG

### 節目經理 Director of Artistic Planning

王昭驊 Joanna WANG

### 音樂企劃組長 Head of Music

黃緯騰 Denny HUANG

### 節目企劃 Programmer

陳達章 Jeff CHEN  
賀淑媛 Lilianna HO

### 節目企劃專案協力 Program Assistant

葉昱姍 YEH Yu-shan

### 藝術事務組長 Head of Artistic Service

蔡紫縈 May TSAI

### 後台規劃 Backstage Coordinator

鄭宇淑 ZHENG Yu-shu  
陳倩宜 Meredith CHEN  
蔡雨諠 TSAI Yu-xuan  
陳宥庄 CHEN Yu-Juang

### 技術經理 Director of Technical Management

陳美玲 CHEN Mei-lin

### 技術協調組長 Head of Technical Coordination

顏嘉煌 Juan YEN

### 技術協調 Technical Coordination

陳芃蓁 CHEN Peng-chen  
曾泓瑋 TSENG Hung-wei

### 舞台技術組長 Head of Stage & Rigging

李慧玲 LEE Hui-ling

### 舞台技術 Stage & Rigging Staff

陳一靈 CHEN Yi-ling

### 燈光技術組長 Head of Lighting

郭建豪 KUO Chien-hao

### 燈光技術 Lighting Staff

黃羽菲 Faye HUANG  
魏伯翰 WEI Bo-han

**視聽技術組長 Head of Audio & Video**

許志偉 Slash HSU

**視聽技術 Audio & Video Staff**

鍾德諺 CHUNG Te-yen  
陳威璵 CHEN Wei-tsung  
林煜堂 LIN Yu-tang

**行銷經理 Director of Marketing  
and Communications**

朱逸群 CHU Yi-chun

**公共關係組長 Head of Public Relation**

涂毓婷 TU Yu-ting

**行銷策略組長 Head of Strategic Marketing**

陳紀臻 CHEN Ji-zhen

**行銷統籌 Marketing Coordinator**

蔡翔任 TSAI Hsiang-jen

**平面設計 Graphic Design**

丁 滢 Roxanne TING

**學推經理 Director of Learning & Participation**

林娟代 Elise LIN

**藝術推廣組長 Head of Arts Participationo**

陳巧儀 Joy CHEN

**藝術推廣 Arts Participation**

黃蕙靜 HUANG Yi-ching

**創意學習組長 Head of Creative Learning**

鄒鳳芝 TSOU Feng-chih

**創意學習 Creative Learning**

陳宜謙 Carina CHEN

**營運經理 Director of Business Development**

王秀暖 Emma WANG

**前台服務組長 Head of Front House**

黃淑綾 HUANG Shu-lin

**前台經理 Front House Service**

黃鈴雅 HUANG Ling-ya

**英文翻譯 English Translation**

謝 綾 HSIEH Lin  
加州翻譯社 California Translations  
楊凱勛 YANG Kai-xun

**特別感謝 Special Thanks**

徐 卉 Mimi XU  
徐麥粒 Maily BEYRENS-XU  
楊守義 YANG Shou-yi  
鄭傑元 CHENG Chieh-yuan  
吉莉安·馬奎爾 Gillian MAGUIRE





# The Tenor 男高音

Jonas KAUFMANN  
in Recital

2025 **3.1** Sat. 19:30

衛武營音樂廳

## 尤納斯·考夫曼

### 獨唱會

承襲20世紀傳奇三大男高音優點，英國《每日電訊報》讚譽為「當今世界最偉大的男高音」

2025年首度登台衛武營音樂廳，邀請您在聲響絕佳音樂聖地，親聞高音之王的動人歌聲

# 魯多維柯·艾奧迪 音樂會

## Ludovico Einaudi



2025  
4.5 Sat. 19:30

衛武營音樂廳  
Weiwuying Concert Hall

《逆轉人生》《遊牧人生》《父親》  
金獎電影配樂大師首度來臺

以極簡音符勾勒夏日時光，讓純真回憶隨旋律盪漾

將於全臺唯一葡萄園式音樂廳中  
奏響義大利國寶琴音，迴盪出絕美琴聲殘響

票價 NTD 600 / 1200 / 1800 / 2400 / 2800 / 3200

[4人同行] 衛武營會員 75折 | 一般大眾 8折

| 購票請洽 |



衛武營 07-262-6666

立即  
購票



National Kaohsiung  
CENTER for ARTS

WEIWUYING

衛武營 國家藝術文化中心

國家表演藝術中心 National Performing Arts Center



# 衛武營國際音樂節

Weiwuying  
International Music Festival

## 4.11 開幕音樂會《愛情故事》

康斯坦丁·特林克斯 & 梁仁模 & 國立臺灣交響樂團

## 4.12 聲繪奇境《月光艾菲爾》

## 4.12 假聲男高音獨唱會—賈斯汀·金與賽瑪《從巴洛克到卡巴萊》

## 4.13 梁仁模小提琴獨奏會《聽。感》

## 4.17 衛武營當代樂團：聲影《音樂遊戲》

## 4.18 衛武營當代樂團：樂舞《美國新章》

## 4.19 《朗基的鋼琴宇宙》

## 4.20 閉幕音樂會《四種氣質》

簡文彬 & 戴佐·朗基 & 高雄市交響樂團

衛武營自開館以來持續推動當代音樂發展，2025年再度邀請國際作曲家陳銀淑擔任藝術總監，以「寂靜的革命」為題，打破時代與音樂邊界，與世界頂尖音樂家、指揮與樂團齊聚音樂廳、表演廳，共同呈現古典與當代音樂的多樣風貌。

## 全系列套票：八檔售票節目各1張享6折

2025

4.11 Fri. ... 4.20 Sun.

了解節目詳情與更多購票優惠



Call Cue 青少年

# 衛武營

#徐亞英 #衛武營 #建築聲學

## 徐亞英與衛武營聲學解密

*Unveiling Weiwuying's Acoustic Design  
by Albert Xu*

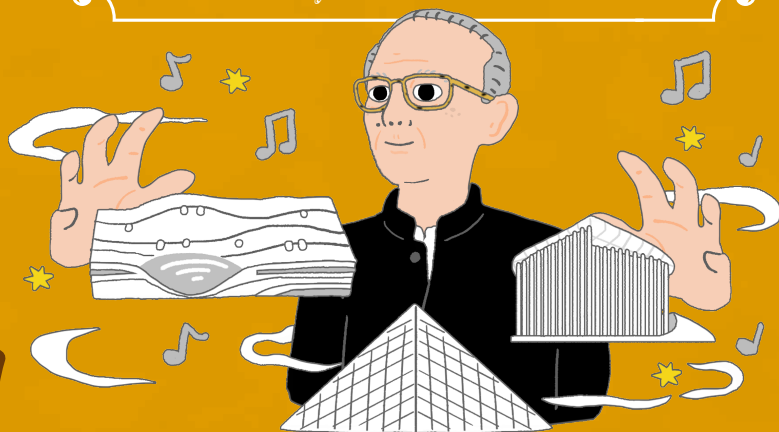

# CUE TO YOUTHS

2024

秋 AUTUMN · WINTER 冬



National Kaohsiung  
CENTER for ARTS  
WEI WU YING  
衛武營 國家藝術文化中心  
國家表演藝術中心 National Performing Arts Center



His favourite hall in the world is the concert hall with mobile ceiling in Weiwuying!

Credit: Maily B. Xu

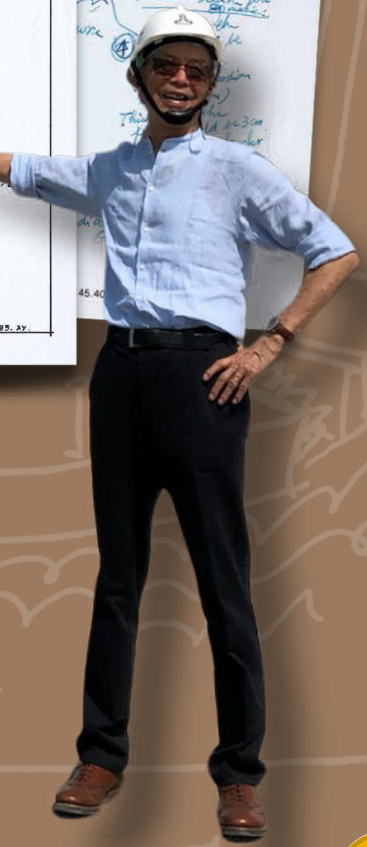





## 那麼，建築聲學到底是什麼？

「基於物理，通過建築，為音樂服務。」

建築聲學是在一座建築興建時便要加入討論的學科，為使空間的聲音清晰、自然，在音樂廳、歌劇院等表演場域更為重要，因為還要考量到表演的聲音如何傳達給觀眾，觀眾如何接收聲音，聽起來如何？涉及物理學、音樂聲學等，利用建築、建材的特性及物理原則去計算、安排。徐亞英談及音樂廳的聲學設計時，如此形容建築聲學家：「我們的工作像是一個翻譯家，要把音樂家抽象的語言，翻譯成物理的指標，這些指標是可測量、可重複的。」

### 偷偷告訴你

在設計衛武營的建築聲學時，因為徐亞英的堅持，興建過程中實驗進行了許多在臺灣從未完成的聲學測試，也成功地應用在衛武營裡頭。可以說是對臺灣未來的聲學設計發展，帶來重大的推進與貢獻！

徐亞英

(11.11.1934-12.06.2023)

國際知名的旅法建築聲學家，出身於建築世家。原本也學建築，某天在大學圖書館看到許多關於聲學的資料，喜歡挑戰的徐亞英便開始研究聲學，並將建築專業與聲學結合，成為全球少數的建築聲學大師之一。

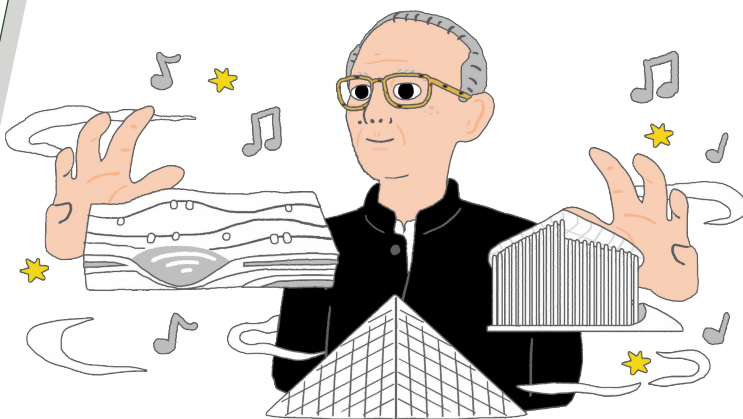

1957年開始專注於建築聲學，徐亞英一生貢獻給建築聲學超過一甲子！他曾與多次獲得被譽為建築界諾貝爾獎的普立茲克獎的國際知名大師貝聿銘、法蘭克·蓋瑞、波宗巴克、里卡多·波菲、保羅·安德魯等大師合作，也一直與音樂家及指揮家充分的交流和合作，在世界各國設計和建造了近百座文化演出和藝術展覽性建築，如知名的法國羅浮宮、巴黎瘋馬夜總會，盧森堡愛樂音樂廳、日本MIHO美秀美術館等。

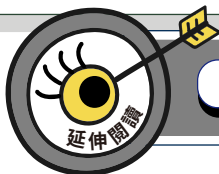

《築音賦聲：建築聲學家徐亞英的六十年構築》

把廳院變成千層酥的內餡！

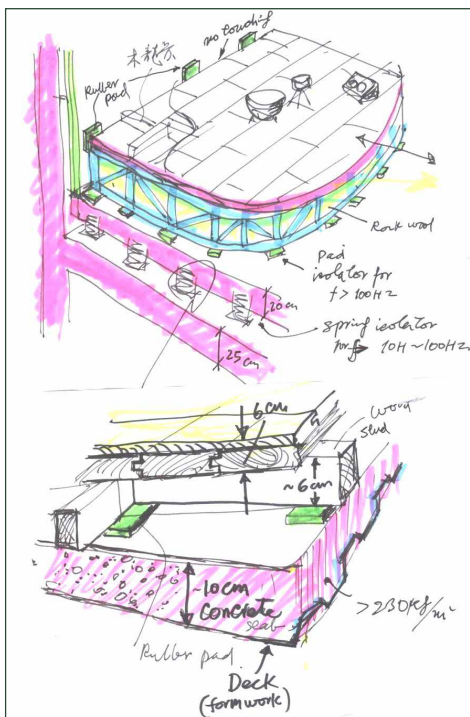

© 徐亞英

設計一個空間的聲學時，聲學家會依需求擬定積極與消極的策略，消極聲學是「阻隔噪音」，積極聲學則是「室內聲學」，讓美好的聲音留在空間裡。

消極  
↓  
阻隔噪音

積極  
↓  
室內聲學

對於音樂廳、歌劇院、戲劇院等需要極安靜演出環境的場所，聲學設計的第一步，就是隔絕交通、戶外集會等外部噪音，以及空調、人為噪音、建築機械震動等內部噪音。

首先，徐亞英在這些場館的屋頂，用多層夾心金屬屋頂做外層，以15公分鋼筋混凝土（RC）隔音內層，輔以空氣層增加隔音。並且以30-50公分的鋼筋混凝土，加上不同厚度與材質的牆、雙道門組成「聲鎖」，搭配多層石膏板牆組成直立多層內外牆。

除此之外，樓板、地面層、天花板，及樓梯和廳堂牆體都有隔音處理。在演奏廳與排練室上下相疊的部分，還採用「盒中盒」的構造隔音。機械設備和鋼結構的隔振當然也不放過。透過一層一層又一層的屋頂、外牆、內殼，形成完全密封的隔音結構，全面阻斷外界噪音。

因此，音樂廳的噪音控制，甚至比睡覺需要的安靜度還高哦！

小試身手

用手邊的小東西，試著打造不同的隔音層！



STEP 1

拿出手機，開始持續播放音樂。

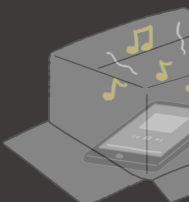

STEP 2

試著用手邊不同的容器，將手機罩起來或蓋住，觀察不同材質與厚度的聲音變化（例如：杯子、紙盒、毛巾、雨衣等）



STEP 3

多試試看不同材質的容器，也可以像俄羅斯娃娃，用2到3個容器將手機罩住，聽聽看聲音有什麼改變

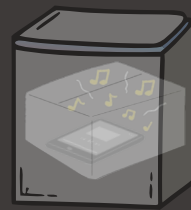

STEP 4

也可以將手機罩起來後，再放進密閉式的抽屜、櫃子，聽聽看聲音會變成怎樣？

## 音樂廳就是一個巨大的樂器

「建築會形塑聲音的流動方向。聲學既以聲音的構築介入建築空間，也處理空間中的留白寂靜，另一面也以體積、形狀和材料為手段，駕馭著無形、無色、即生即滅的聲波，塑造出一個有功能性的音場，把灰色地帶留給殘響，成就出一個激盪靈魂的聲音場所。」——摘自《築音賦聲：建築聲學家徐亞英的六十年構築》

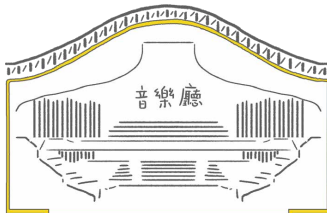

這是徐亞英談音樂廳的建築聲學設計。原來的音樂廳屋頂設計，是像貝殼一樣的拱形，在考量聲學設計後，才修改為現在的反曲面設計。徐亞英將音樂廳當成一個樂器來設計，而通過音樂廳發出的聲音，就是樂隊的延長。

## 葡萄園式的環繞音響

傳統的音樂廳大多以長方形呈現一種鞋子盒式的空間，前三分之一是舞台，觀眾席非常方正地集中排列在舞台前，很像我們常見的電影院或教堂。而衛武營的音樂廳是全臺獨一無二的葡萄園式設計，可以容納更多的觀眾，演奏者在中心，座位圍繞著表演區呈幾何梯形上升，演奏者被觀眾圍繞，不僅讓演出者和觀眾之間的距離更緊密，即使是不用任何擴音設備的「自然聲音」，各區觀眾也都能聽到從側面來的反射音，加強樂聲立體環繞的空間感。

除了觀眾席的設計，建築中天花板也強化了讓觀眾有被音樂包圍的感受。徐亞英在音樂廳使用了MLS (Maximum-Length Sequence) 原理設計的多曲面體天花板及牆面，利用溝槽的深淺及間距提供不同能量及「短時差」的反射聲，可以將舞台上的聲音更均質的擴散傳到廳內的每個座位。

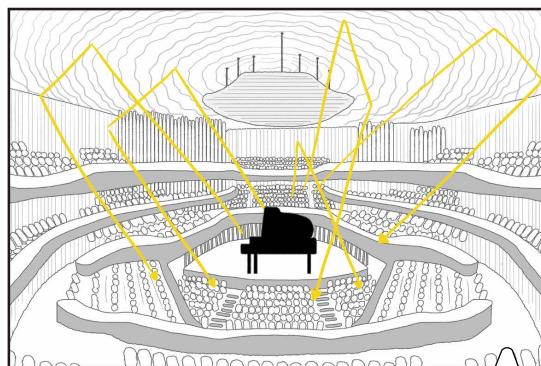

### 均等的享受

衛武營的音樂廳中沒有包廂（跳台），因而也沒有座位上方會被遮擋，所有觀眾都可以享受來自天花板的反射聲，以及均等的聲音享受！

### 小試身手



### 尋找最好聽的甜蜜點

準備好你的耳朵，訓練聽力的時刻到了！先從在家看電視、使用電腦開始，再進階到戶外、或室內參加有聲音的活動，找找你覺得最好聽的甜蜜點！



1 試著站到不同位置，聽聽看，找到你覺得聲音傳遞最清楚、音質最好聽的位置。



2 觀察一下，你和發聲來源的相對位置，以及周遭環境有什麼？



3 為什麼那個位置是你認為最好聽的位置呢？試著畫下會影響聲音的相對位置圖。



4 把這些圖拍下來，存在手機相簿裡。下一次到類似的空間、場合時，尋找屬於你的甜蜜點吧！



## 殘響：餘音繞樑，三日不絕？

你有沒有去過隧道、洞穴或教堂？在那裡面和外面的聲音有什麼不同？或者家裡的浴室，聲音是不是和客廳不太一樣呢？那是因為這些空間的殘響時間特別長喔！

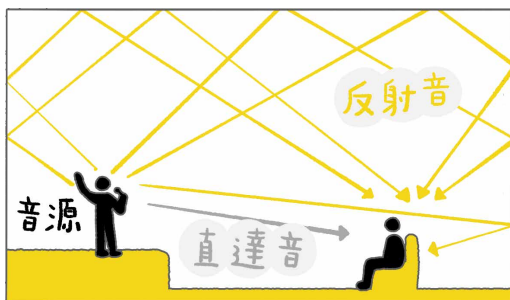

不同空間的大小、形狀、材質、密閉與開放程度、開口位置等都影響我們的聽覺感受，其中很大一部分來自聲音的「殘響」，也就是聲源的反射聲，殘響時間則是聲源停止發聲後，聲音繼續留在空間裡的時間。音樂廳的聲學設計必須嚴謹地計算聲源直達觀眾耳裡加上反射的殘響，以及折射、衍射、吸收、擴散等物理變化，使聲波疊合後產生的混響效果。混響做得好，便是餘音繞樑；做得差，聲音就糊成一團。

## 是誰把聲音都集中在這裡！——音響反射板

除了前面提到的天花板及觀眾席設計都考量了反射聲，徐亞英更在演奏台上方，垂掛一片可調節高度和角度的**蟹殼型音響反射板**，可依不同樂風和指揮需求，讓樂團成員能夠清楚聽到自己的樂器聲音以控制音量，同時也能清楚地聽見彼此的聲音。

此外，天花板、牆面和演奏台上方的反射板材質都很講究，採用厚重的玻璃纖維強化石膏板，防止輕薄板材造成低頻吸音過度，犧牲了交響樂雄厚飽滿的低音。

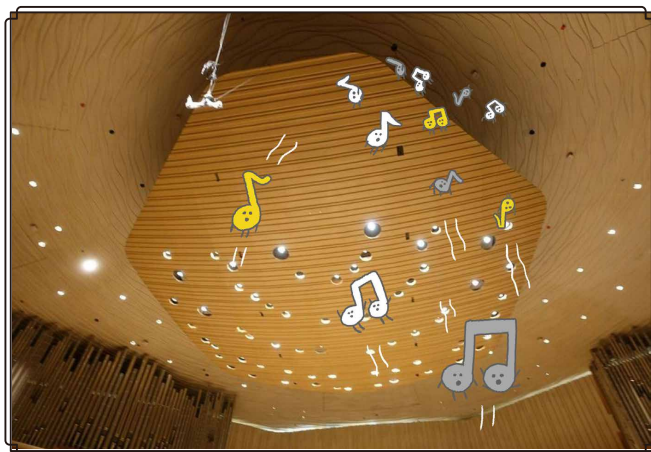

## 榕樹廣場：靈機一動打造聲音景觀

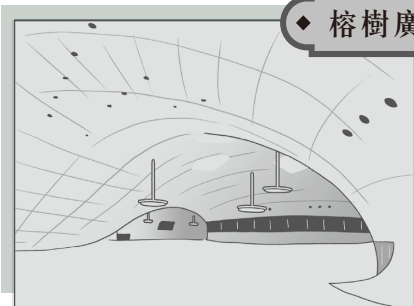

建築師從榕樹得到靈感，為榕樹廣場建造了以彎曲鋼板焊接而成的拱頂。但堅硬的拱頂加上水泥地板會讓聲音在裡頭交互反射，造成轟隆巨響。要在拱頂上開上千個孔洞來減少殘響時間也不是個好辦法，於是徐亞英實際測試，發現在廣場的不同位置演奏有不一樣的殘響時間，不如乾脆讓這特殊現象，成為獨特的聲音地景（Soundscape）！

Call Cue 青少年

# 衛武營



更多資源

意見調查表

出版：國家表演藝術中心衛武營國家藝術文化中心

董事長：高志尚

發行人：簡文彬

總編輯：林娟代

企劃執行：鄒鳳芝、陳宜謙

內容編輯：許雁婷

主編：蔡瑞伶

設計：劉丁菱

插圖：aminwu

特別感謝：侯慶謀建築師



National Kaohsiung  
CENTER FOR ARTS

WEI WUYING

衛武營 國家藝術文化中心

國家表演藝術中心 National Performing Arts Center

協力  
贊助

 玉山文教基金會

GPN : 4811300018

Call Cue 青少年

# 衛武營

#徐亞英 #衛武營 #建築聲學

## 徐亞英與衛武營聲學解密

Unveiling Weiwuying's Acoustic Design  
by Albert Xu

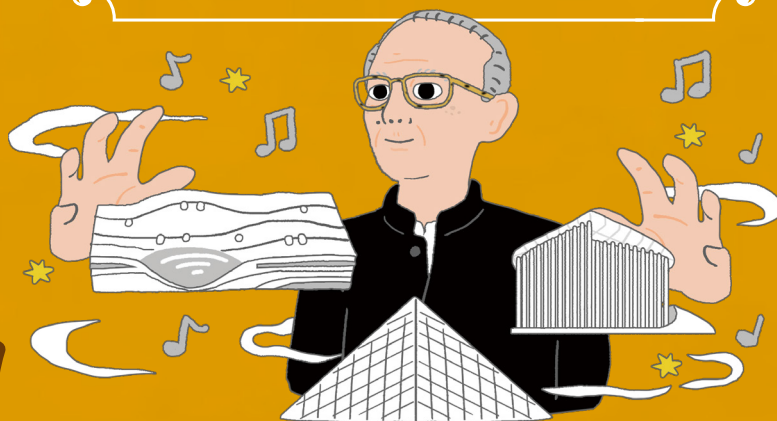

# CUE TO YOUTHS

2024

秋 AUTUMN · WINTER 冬



National Kaohsiung  
CENTER for ARTS  
WEI WU YING  
衛武營 國家藝術文化中心  
國家表演藝術中心 National Performing Arts Center

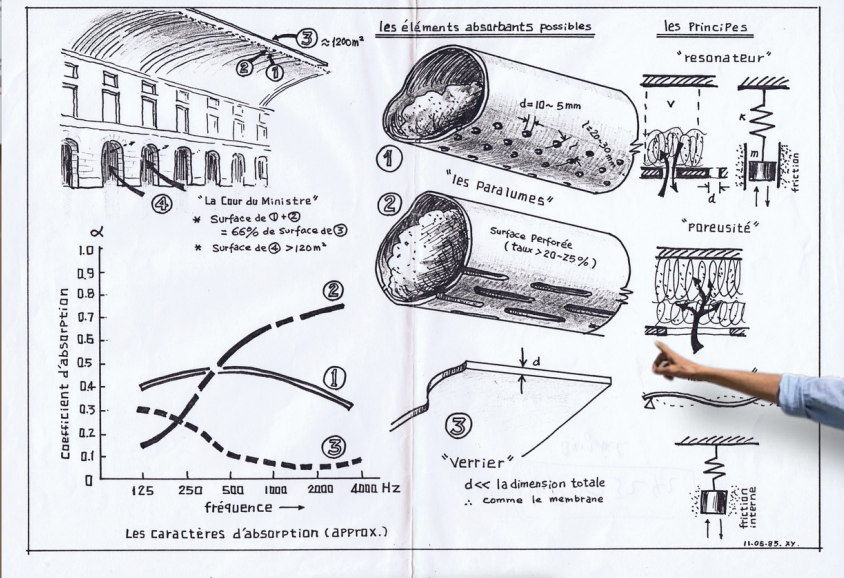
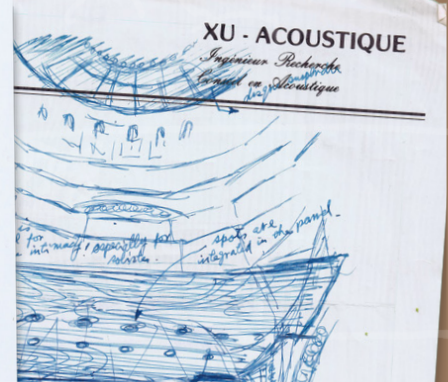
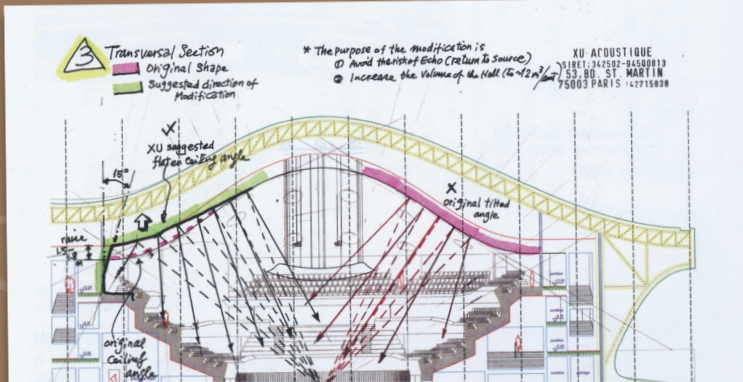

His favourite hall in the world is the concert hall with mobile ceiling in Weiwuying!



Credit: Maïly B. Xu

In 2005, the Council for Economic Planning and Development of the Executive Yuan held a competition for the design of the National Kaohsiung Center for the Arts (Weiwuying), which was won by the Dutch firm Mecanoo Architecten, led by Francine HOUBEN, along with Archasia Design Group and Albert XU's XU Acoustique.

Inspired by the natural ecology of southern Taiwan and its tropical climate, HOUBEN's organic design is one that breathes and boasts many open spaces. Each side of the building has entrances that are open to the Banyan Plaza and Outdoor Theater. The curved roof descends smoothly down to kiss the lawn on two sides, forming an outdoor amphitheater and stage, and it is a great place for a stroll too. With such a uniquely designed building, it should not be hard to imagine the difficulty of ensuring the acoustics would be up to the standards

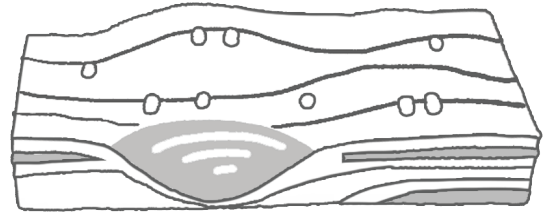

required for a national performing arts center.

Acoustic design refers to creating the ideal sound environment in a venue so that members of the audience may have the optimal listening experience regardless of where they are seated. This aspect of a high-quality performance is a coordinated combination of architecture, structure, and a variety of skills, including sound and vibration insulation, that allow the sounds produced on stage to be properly transmitted. While at Weiwuying, you will find that despite being located in a busy

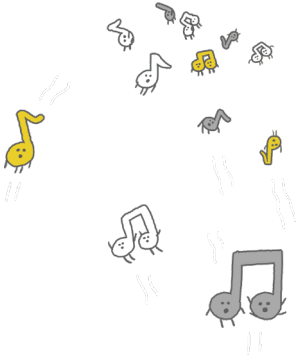

area of the city, even the semi-open area of Banyan Plaza has a sense of tranquility. Thus, the acoustic designer took into account not just the indoor venues but the entire building. The Concert Hall has quite a unique feature: The music seems to come from all directions in Taiwan's sole music venue with vineyard-style seating. The outstanding acoustics at Weiwuying are the result of the expertise of both the architectural team and Albert XU.

**The Memorial Concert for  
the Master of Architectural  
Acoustics-Albert XU**

Date/Time

12.07 (Sat.) 19:30

Location

**Weiwuying Concert Hall**



## So what is architectural acoustics?

"A service to music made possible by architecture based on physics."

Architectural acoustics is an aspect that must be discussed when a performing arts center is being designed to make sure the sound is clear and natural, especially in such venues as a concert hall and opera house, because how the sound is transmitted to the audience and how they receive it are of utmost importance. The discipline involves physics, music acoustics, and figuring out how to make use of the architecture, building materials, and principles of physics. Albert XU described architectural acousticians in this way while discussing the acoustic design of the Weiwuying Concert Hall: "[We] act as translators, converting the abstract expressions of musicians into physical, measurable, and repeatable indicators."

### A little secret

During the construction of Weiwuying, XU insisted that a number of acoustic tests be conducted that had never before been done in Taiwan.

This was a major advancement in and contribution to the future of acoustic design in Taiwan.

(11.11.1934-12.06.2023)

Albert XU

Albert XU, who came from a family with architecture in its blood, was an internationally renowned acoustician based in France. He originally studied architecture, but one day in the university library, he happened upon information about acoustics. Always up for a challenge, he delved into this new field, incorporating his architectural knowledge into acoustic design to become one of the world's few great architectural acousticians.

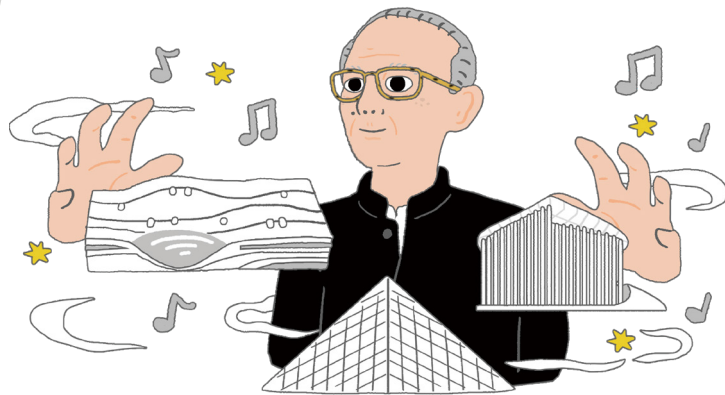

In 1957, he began to focus on architectural acoustics, a path he stayed on for over 60 years! He has collaborated with Ieoh Ming PEI, Frank GEHRY, and Christian de PORTZAMPARC, all of whom are Pritzker Architecture Prize (the architectural realm's equivalent to the Nobel Prize) laureates, as well as with such great names as Ricardo Bofill LEVÍ and Paul ANDREU. He spent a considerable amount of time engaging and cooperating with musicians and conductors and was part of the construction of nearly 100 art and culture venues all over the world, including the Louvre, Le Crazy Horse de Paris, the Philharmonie Luxembourg, and the Miho Museum in Japan.

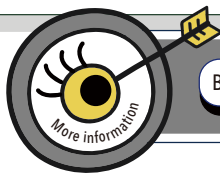

Building for Music: Albert Xu and His Works of Architecture Design

## Building mille-feuille pastries!

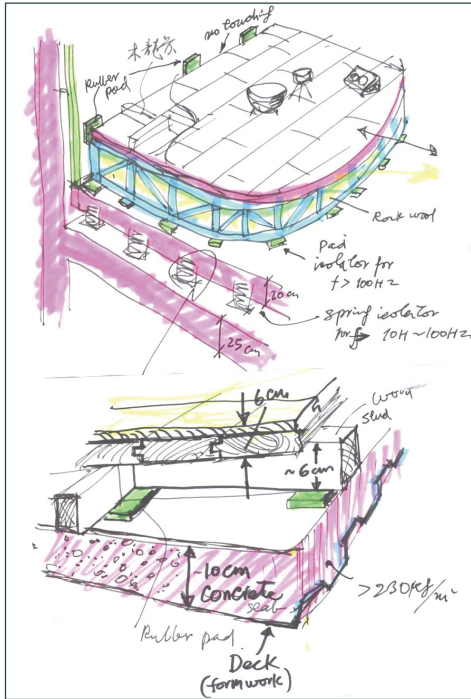

When designing the acoustics of a space, the acoustician formulates active and passive strategies based on the needs, the former referring to room acoustics and the latter referring to soundproofing, both of which are aimed at keeping sound inside the space.

Passive  
↓  
Soundproofing

Active  
↓  
Room Acoustics

For the Concert Hall, Opera House, Playhouse, and Recital Hall, which require an extremely quiet environment, the first step in acoustic design is to soundproof the venue from external (traffic and people) and internal (air conditioners, people, and machinery within the building) noises.

First, XU placed multiple layers of metal sandwich panels on the roofs of these structures and, continuing inward, 15 centimeters of reinforced concrete and then a layer of air. The walls consist of 30-50 centimeters of reinforced concrete as well as varying thicknesses of different materials and two sets of doors at entry points. Together, they make the perfect sound lock. In addition, there are multilayered glass fiber reinforced gypsum panels on the interior and exterior of the walls. Furthermore, the floor slabs, ground slab, ceilings, stairs, and walls of the venues have been soundproofed. A "box-in-a-box" approach was applied to the shared surface between the Recital Hall and Rehearsal Studio. Vibration insulation for the mechanical equipment and steel structure was also a must. Thus, with the multilayered roof, exterior walls, and interior shells, the structure is completely closed off and soundproof from unwanted noise. As a result, the silence of the Concert Hall exceeds that needed to fall asleep!

Give it a try

### Make different sound insulation layers with everyday items!



STEP 1

Start playing some music on your phone.



STEP 2

Cover your phone with different items (cups, cardboard boxes, towels, raincoats, etc.) and notice the different effects produced by items of differing thicknesses and materials.



STEP 3

Try out these different materials in combinations, like two or three items stacked on one another to see how the sound changes.

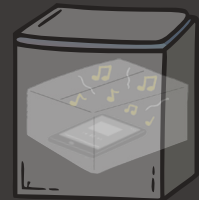

STEP 4

Cover your phone and then put it in a drawer or cabinet to see what effect is produced.

## The Concert Hall, a massive instrument in its own right

"The architecture shapes the directional flow of sound. The acoustics intervene in architectural space through the construction of sound and address the silence and negative space within the space. In addition, they drive the unseen, colorless, waves of sound that emerge and instantly dissipate through the use of volume, shape, and material to form a functional sound field, leaving a gray area for reverberation and creating a sound space that resonates with the soul."

From Building for Music: Albert Xu and His Works of Architecture Design

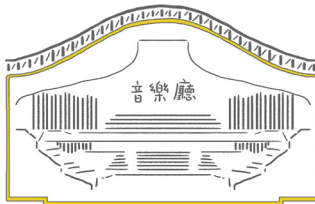

This is XU's architectural acoustic design for the Concert Hall. The design of the ceiling was originally to be a shell-like arch, but when the acoustics were further considered, the current design of a concave surface was opted for instead. XU viewed the hall as a musical instrument that would serve as an extension of the ensemble performing on stage.

## Surround sound of vineyard-style seating

Concert halls are traditionally rectangular in shape, the front third being the stage and the remaining space being a uniform arrangement of rows of seats for the audience, much like a movie theater or church. But the Concert Hall is one-of-a-kind in Taiwan because of its vineyard-style seating, which allows for a larger audience. The performers are in the middle, from where the seating rises in differing tiers of trapezoidal sections. This design not only brings the audience closer to the performers but also means that sound is reflected from the side to the listeners (no matter where they are sitting) without the aid of an amplification system, giving the music a more three-dimensional feel.

The ceiling adds to the surround sound sensation. XU applied maximum-length sequence principles in his design of the ceiling and walls, which curve in a variety of ways, utilizing the depth and spacing of the grooves to provide "short-delay" reflections of different types of energy. This allows the sound from the stage to project relatively evenly to each of the seats in the hall.

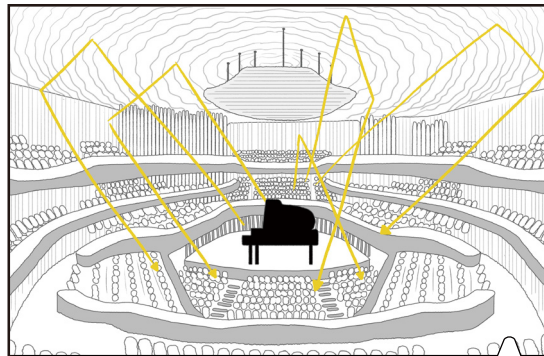

### Seating equality

There is no box seating in Weiwuying's Concert Hall, which means no seats are blocked off from the ceiling. In this way, every member of the audience equally receives the sound reflected by the ceiling.

Give it a try



### Find the sweet spot

It's time to train your ears! Start with watching TV or using your computer at home, and then progress on to the outdoors or to indoor events to find the aural sweet spot.



1 Listen from different places and find the spot from which the sound is clearest and of the best quality.



2 Make mental notes of where you are in relation to the source of the sound and what is in your surroundings.



3 Why does that spot give you the best listening experience? Draw pictures of the positions of where you are and other things that influence your experience.



4 Take pictures of these drawings and keep them in an album in your phone. The next time you go to a similar space, use them to help find the sweet spot!



## Reverberation: Making a lasting impression

Think about being in a tunnel, cave, or church. What is different about the sounds inside and outside? Or have you noticed a difference in sound in your bathroom and living room? The difference comes from reverberation length.



Differences in the size, shape, material, and degree of openness of a space as well as the orientation of its doors/windows affect how we perceive sounds, a major part of that being reverberation, which is the reflection of sound once it has been emitted from its source. Reverberation length refers to how long a sound persists in a space after the source has stopped producing it. The acoustic design of a music hall requires precise calculations of how fast a sound will travel from its source to the audience, the reverberation length, and the physical variations in reflection, diffraction, absorption, and diffusion, all of which lead to reverberation through the overlapping of sound waves. When the reverberation is right, the sound produces a lasting impression on the audience; when it is not, the sound becomes a jumbled mess.

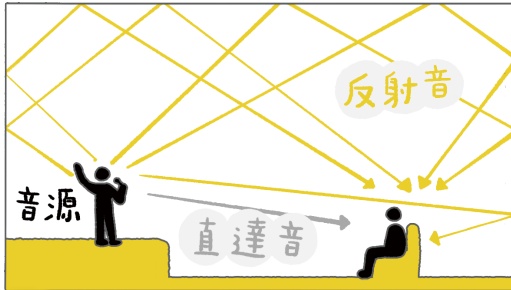

## Directing sound with acoustic shells

Besides considering sound reflection in the abovementioned ceiling and seating, XU also had an acoustic shell in the shape of a crab carapace hung over the stage. The height and angle can be adjusted based on the kind of music to be played so that the musicians can clearly hear what they themselves and their fellow performers are playing for the sake of volume control. The shells on the ceiling and walls and above the stage are made of a particular material—thick glass fiber reinforced gypsum panels. This prevents the problem of excessive low-frequency sound absorption that thin panels pose, that is, the loss of the rich, full sound of bass notes.



## Banyan Plaza: Happening upon a unique soundscape

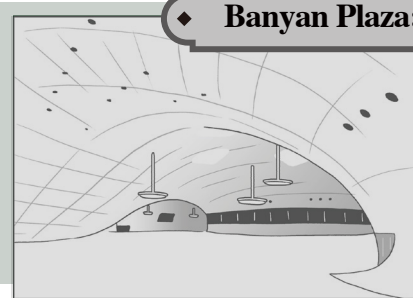

Inspired by banyan trees, HOU BEN designed Banyan Plaza with an arched roof made of curved steel panels welded together. The designers assumed the hard panels and cement floor would cause sound to reflect repeatedly off different surfaces, causing a loud, unpleasant roar, but boring countless holes into the ceiling to reduce reverberation was not something they felt to be a good idea. So XU carried out experiments to find the different reverberation lengths at different spots and ultimately realized it would in fact be nice to leave this unique soundscape as it is.

Call Cue 青少年

# 衛武營



More Programs

意見調查表

Published by National Kaohsiung Center for the Arts (Weiwuying)

Chairman of Board of Directors: Henry KAO

General and Artistic Director: CHIEN Wen-pin

Chief Editor: Elise LIN

Producer: TSOU Feng-chih, Carina CHEN

Project Editor: Yenting HSU

Executive Editor: Stella TSAI

Graphic Design: Orange LIU

Illustrations: aminwu

Special Thanks to HOU Ching-mou Architect



National Kaohsiung  
CENTER for ARTs

WEIWUYING

衛武營 國家藝術文化中心  
國家表演藝術中心 National Performing Arts Center

協力  
贊助



GPN : 4811300018

返回目錄  
Go Top

衛武營節目線上問卷  
Weiwuying Online Questionnaire

Copyright © 2024 National Kaohsiung Center for the Arts (Weiwuying) All rights reserved.

版權聲明 © 2024 衛武營國家藝術文化中心 版權所有

+886-7-262-6666

[www.npac-weiwuying.org](http://www.npac-weiwuying.org)

指導單位



協力贊助





National Kaohsiung  
CENTER FOR THE ARTS

WEI WU YING

衛武營 國家藝術文化中心

國家表演藝術中心 National Performing Arts Center